

2024



RACCORD INDUSTRIEL COLLIER DE SERRAGE

Découvrez notre catalogue d très large choix de raccords et adaptateurs en aluminium, inox, bronze et polypro.

SOMMAIRE



PAGE 09-20

RACCORD SYMÉTRIQUE
ALUMINIUM



PAGE 21-26

RACCORD SYMÉTRIQUE
BRONZE



PAGE 27-33

RACCORD SYMÉTRIQUE
INOX



SOMMAIRE



PAGE 34-36

RACCORD SYMÉTRIQUE
POLYPRO



PAGE 37-40

ACCESSOIRES
POUR RACCORD SYMÉTRIQUE



PAGE 41-46

RACCORD STORZ

SOMMAIRE



PAGE 47-53

RACCORD EXPRESS ET COLLIERS



PAGE 54-56

RACCORD GEKA



PAGE 57-61

RACCORD À CAME ALUMINIUM



SOMMAIRE



PAGE 62-66

RACCORD CAME LAITON



PAGE 67-71

RACCORD CAME INOX



PAGE 72-76

RACCORD CAME
POLYPROPYLENE



SOMMAIRE

PAGE 77-79



JOINT POUR RACCORD A CAME

PAGE 80-83



RACCORD TANKWAGEN



PAGE 84-92



BRIDES ACIER



SOMMAIRE

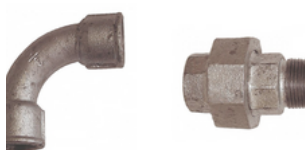

PAGE 93-113

RACCORD EN ACIER GALVANISE

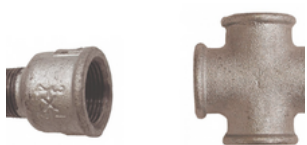

PAGE 114-122

RACCORD ACIER NOIR A SOUDER



PAGE 123-138

COLLIERS



1- RACCORD SYMÉTRIQUE ALUMINIUM

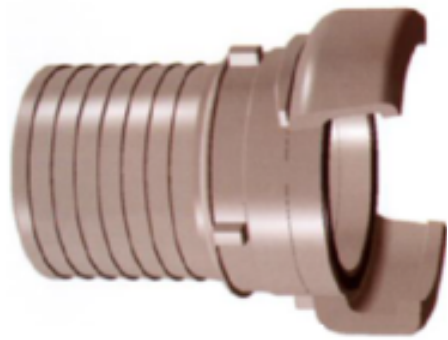

Demi raccord à douille crantée alu

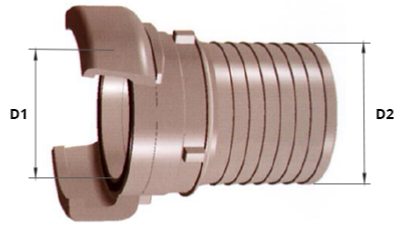

Demi raccord à douille crantée alu

Matière : Aluminium

Code	Référence	D1	D2	D3	Poids
000150	1/2 SYM ALU 20/25	20mm	25mm		0
043285	1/2 SYM ALU 25/25	25mm	25mm		0
000151	1/2 SYM ALU 25/30	25mm	30mm		0
000152	1/2 SYM ALU 32/32	32mm	32mm		0
000153	1/2 SYM ALU 32/35	32mm	35mm		0
000154	1/2 SYM ALU 40/35	40mm	35mm		0
000155	1/2 SYM ALU 40/40	40mm	40mm		0
000156	1/2 SYM ALU 40/45	40mm	45mm		0
000157	1/2 SYM ALU 50/45	50mm	45mm		0
000158	1/2 SYM ALU 50/51	50mm	51mm		0.33
000159	1/2 SYM ALU 50/55	50mm	55mm		0
000160	1/2 SYM ALU 65/63	65mm	63mm		0
000161	1/2 SYM ALU 65/70	65mm	70mm		0
000162	1/2 SYM ALU 80/76	80mm	76mm		0
000163	1/2 SYM ALU 80/80	80mm	80mm		0
000164	1/2 SYM ALU 80/90	80mm	90mm		0
000146	1/2 SYM ALU 100/102	100mm	102mm		1.07
000148	1/2 SYM ALU 100/105	100mm	105mm		0
000149	1/2 SYM ALU 100/110	100mm	110mm		0
045457	1/2 SYM ALU 125/125	125mm	125mm		0
030076	1/2 SYM ALU 150/150	150mm	150mm		0

Jonction symétrique alu avec verrou



Jonction symétrique alu avec verrou

Matière : Aluminium

Code	Référence	D1	D2	D3	Poids
FEM					
008722	JONCT SYM ALU 25F1"	25mm	FEM 1"		0.08
008724	JONCT SYM ALU 32F1"1/4	32mm	FEM 1"1/4		0
008726	JONCT SYM ALU 40F1"1/2	40mm	FEM 1"1/2		0.22
008733	JONCT SYM ALU 50F2"	50mm	FEM 2"		0
008737	JONCT SYM ALU 65F2"1/2	65mm	FEM 2"1/2		0
008740	JONCT SYM ALU 80F3"	80mm	FEM 3"		0
008718	JONCT SYM ALU 100F4"	100mm	FEM 4"		0
045458	JONCT SYM ALU 125F5"	125mm	FEM 5"		0
028847	JONCT SYM ALU 150F6"	150mm	FEM 6"		0
MALE					
008723	JONCT SYM ALU 25M1"	25mm	MALE 1"		0.07
008725	JONCT SYM ALU 32M1"1/4	32mm	MALE 1"1/4		0.11
008729	JONCT SYM ALU 40M1"1/2	40mm	MALE 1"1/2		0.16
008735	JONCT SYM ALU 50M2"	50mm	MALE 2"		0
008739	JONCT SYM ALU 65M2"1/2	65mm	MALE 2"1/2		0
008741	JONCT SYM ALU 80M3"	80mm	MALE 3"		0
008719	JONCT SYM ALU 100M4"	100mm	MALE 4"		0
035093	JONCT SYM ALU 150M6"	150mm	MALE 6"		0

Boite symétrique alu male et femelle

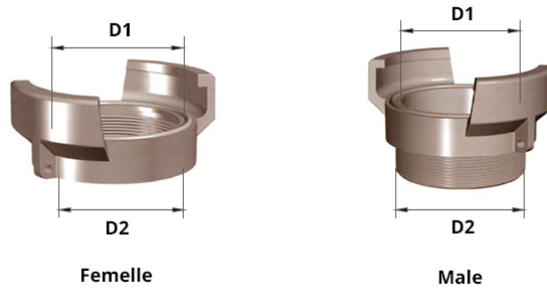

Boite symétrique alu male et femelle

Matière : Aluminium

Code	Référence	D1	D2	D3	Poids
FEM					
005868	BOITE SYM ALU 20F3/4	20mm	FEM 3/4		0
005870	BOITE SYM ALU 25F1"	25mm	FEM 1"		0
005872	BOITE SYM ALU 32F1"1/4	32mm	FEM 1"1/4		0
005874	BOITE SYM ALU 40F1"1/2	40mm	FEM 1"1/2		0
005876	BOITE SYM ALU 50F2"	50mm	FEM 2"		0
005878	BOITE SYM ALU 65F2"1/2	65mm	FEM 2"1/2		0
005880	BOITE SYM ALU 80F3"	80mm	FEM 3"		0
005866	BOITE SYM ALU 100F4"	100mm	FEM 4"		0
MALE					
005869	BOITE SYM ALU 20M3/4	20mm	MALE 3/4		0
005871	BOITE SYM ALU 25M1"	25mm	MALE 1"		0
005873	BOITE SYM ALU 32M1"1/4	32mm	MALE 1"1/4		0.08
005875	BOITE SYM ALU 40M1"1/2	40mm	MALE 1"1/2		0
005877	BOITE SYM ALU 50M2"	50mm	MALE 2"		0
005879	BOITE SYM ALU 65M2"1/2	65mm	MALE 2"1/2		0.23
005881	BOITE SYM ALU 80M3"	80mm	MALE 3"		0
005867	BOITE SYM ALU 100M4"	100mm	MALE 4"		0

Réduction symétrique alu

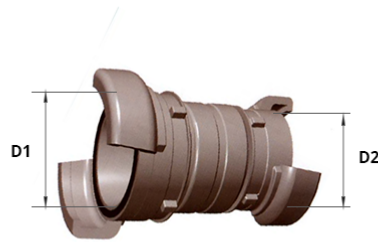

Réduction symétrique alu

Matière : Aluminium

Code	Référence	D1	D2	D3	Poids
018992	REDUC SYM ALU 40/20	40mm	20mm		0
018993	REDUC SYM ALU 40/25	40mm	25mm		0
018994	REDUC SYM ALU 40/32	40mm	32mm		0
018995	REDUC SYM ALU 50/32	50mm	32mm		0
010597	REDUC SYM ALU 50/40	50mm	40mm		0
010598	REDUC SYM ALU 65/40	65mm	40mm		0
010599	REDUC SYM ALU 65/50	65mm	50mm		0
010600	REDUC SYM ALU 80/40	80mm	40mm		0
010601	REDUC SYM ALU 80/50	80mm	50mm		0
010602	REDUC SYM ALU 80/65	80mm	65mm		0
010593	REDUC SYM ALU 100/40	100mm	40mm		0
010594	REDUC SYM ALU 100/50	100mm	50mm		0
010595	REDUC SYM ALU 100/65	100mm	65mm		0
010596	REDUC SYM ALU 100/80	100mm	80mm		0
069464	REDUC SYM ALU 125/100	125mm	100mm		0
032178	REDUC SYM ALU 150/100	150mm	100mm		0
100894	REDUC SYM ALU 150/125	150mm	125mm		0

Bouchon symétrique alu avec/sans verrou



Avec verrou



à poignée
(sans verrou)



Cadenassable

Bouchon symétrique alu avec/sans verrou

Matière : Aluminium

Code	Référence	D1	D2	D3	Poids
AVEC VERROU					
005900	BOUCH SYM ALU 20	20mm			0
005901	BOUCH SYM ALU 25	25mm			0
005902	BOUCH SYM ALU 32	32mm			0
005903	BOUCH SYM ALU 40	40mm			0
005904	BOUCH SYM ALU 50	50mm			0
005905	BOUCH SYM ALU 65	65mm			0
005906	BOUCH SYM ALU 80	80mm			0
005899	BOUCH SYM ALU 100	100mm			0
102047	BOUCH SYM ALU 125	125mm			0
028848	BOUCH SYM ALU 150	150mm			0
CADENASSABLE					
064728	BOUCH SYM ALU CADENASSABLE 50	50mm			0
027580	BOUCH SYM ALU CADENASSABLE 80	80mm			0
066154	BOUCH SYM ALU CADENASSABLE 100	100mm			0
SANS VERROU					
005892	BOUCH P. SYM ALU 50	50mm			0
005893	BOUCH P. SYM ALU 65	65mm			0
005894	BOUCH P. SYM ALU 80	80mm			0
005890	BOUCH P. SYM ALU 100	100mm			0

Transformation symétrique/express

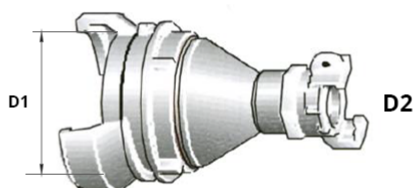

Transformation symétrique/express

Matière : Aluminium

Code	Référence	D1	D2	D3	Poids
045036	TRANS SYM ALU 25/EXPRESS	25mm	EXPRESS		0
012900	TRANS SYM ALU 40/EXPRESS	40mm	EXPRESS		0
035089	TRANS SYM ALU 50/EXPRESS	50mm	EXPRESS		0
012901	TRANS SYM ALU 65/EXPRESS	65mm	EXPRESS		0
035090	TRANS SYM ALU 80/EXPRESS	80mm	EXPRESS		0

Division avec robinets à volant

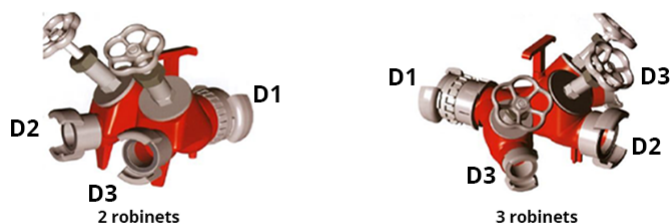

Division avec robinets à volant

Code	Référence	D1	D2	D3	Poids
2 ROBINETS					
007163	DIV SYM ALU 65 40/40	DN 65	DN 40	DN 40	0
035106	DIV SYM ALU 65 65/65	DN 65	DN 65	DN 65	0
035107	DIV SYM ALU 100 65/65	DN 100	DN 65	DN 65	0
100870	DIV SYM ALU 100 100/100	DN 100	DN 100	DN 100	0
3 ROBINETS					
035108	DIV SYM ALU 65 40/65/40	DN 65	DN 65	DN 40	0
035109	DIV SYM ALU 100 65/65/65	DN 100	DN 65	DN 65	0

Robinet aluminium

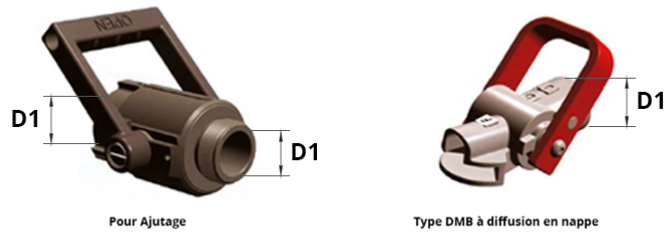

Robinet aluminium

Code	Référence	D1	D2	D3	Poids
POUR AJUTAGE					
010698	ROB ALU MF 40/36X200	M36X200			0
010695	ROB ALU MF 65/52X300	M52X200			0
TYPE DMB					
010694	ROB ALU DMB 20/7-7	M24X200			0
010693	ROB ALU DMB 40/12-12	M36X200			0
018996	ROB ALU DMB 65/18-15	M52X200			0

Fût de lance et ajutage

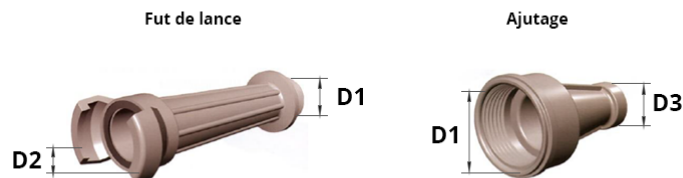

Fût de lance et ajutage

Matière : Aluminium

Code	Référence	D1	D2	D3	Poids
AJUTAGE					
005464	AJUTAGE DN20/6	M24X200		6mm	0
035100	AJUTAGE SYM ALU 40/14	M36X200		14mm	0
005465	AJUTAGE SYM ALU 40/12	M36X200		12mm	0
005466	AJUTAGE SYM ALU 65/18	M52X200		18mm	0
FUT DE LANCE					
007957	FUT SYM ALU 20/24X200	M24X200	DN20		0
007958	FUT SYM ALU 40/36X200	M36X200	DN40		0
007959	FUT SYM ALU 65/52X300	M52X200	DN65		0

Adapteur alu

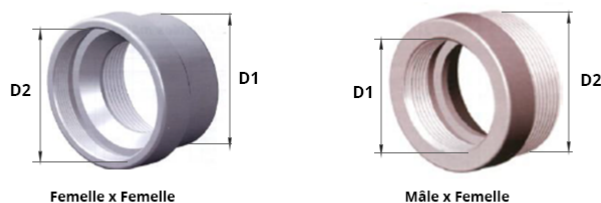

Adapteur alu

Matière : Aluminium

Code	Référence	D1	D2	D3	Poids
FEM X FEM					
020125	BAGUE ALU F3/4XF3/4	FEM 3/4	FEM 3/4		0
020123	BAGUE ALU F1"XF1"	FEM 1"	FEM 1"		0
020124	BAGUE ALU F1"XF3/4	FEM 1"	FEM 3/4		0
020121	BAGUE ALU F1"1/2XF1"1/4	FEM 1"1/4	FEM 1"1/4		0
020122	BAGUE ALU F1"1/2XF1"	FEM 1"1/2	FEM 1"		0
020120	BAGUE ALU F1"1/2XF1"1/2	FEM 1"1/2	FEM 1"1/2		0
020109	BAGUE ALU F2"XF1"1/2	FEM 2"	FEM 1"1/2		0
020116	BAGUE ALU F2"XF2"	FEM 2"	FEM 2"		0
020110	BAGUE ALU F2"1/2XF1"1/2	FEM 2"1/2	FEM 1"1/2		0
020111	BAGUE ALU F2"1/2XF2"	FEM 2"1/2	FEM 2"		0
020117	BAGUE ALU F2"1/2XF2"1/2	FEM 2"1/2	FEM 2"1/2		0
020112	BAGUE ALU F3"XF2"	FEM 3"	FEM 2"		0
020113	BAGUE ALU F3"XF2"1/2	FEM 3"	FEM 2"1/2		0
020118	BAGUE ALU F3"XF3"	FEM 3"	FEM 3"		0
020114	BAGUE ALU F4"XF2"1/2	FEM 4"	FEM 2"1/2		0
020115	BAGUE ALU F4"XF3"	FEM 4"	FEM 3"		0
020119	BAGUE ALU F4"XF4"	FEM 4"	FEM 4"		0
028301	BAGUE ALU F4"1/2XF4"	FEM 4"1/2	FEM 4"		0
093723	BAGUE ALU F6"XF4"	FEM 6"	FEM 4"		0
MALE X FEM					
020139	BAGUE ALU M1"XF1"1/2	MALE 1"	FEM 1"1/2		0
020138	BAGUE ALU M1"1/4XF1"	MALE 1"1/4	FEM 1"		0
020137	BAGUE ALU M1"1/2XF1"	MALE 1"1/2	FEM 1"		0
020136	BAGUE ALU M1"1/2XF1"1/4	MALE 1"1/2	FEM 1"1/4		0
020134	BAGUE ALU M2"XF1"	MALE 2"	FEM 1"		0
020140	BAGUE ALU M1"1/2XF2"	MALE 1"1/2	FEM 2"		0
020103	BAGUE ALU M2"XF1"1/2	MALE 2"	FEM 1"1/2		0
020135	BAGUE ALU M2"1/2XF1"1/4	MALE 2"1/2	FEM 1"1/4		0
020106	BAGUE ALU M2"1/2XF1"1/2	MALE 2"1/2	FEM 1"1/2		0
020098	BAGUE ALU M2"1/2XF2"	MALE 2"1/2	FEM 2"		0
020104	BAGUE ALU M3"XF2"1/2	MALE 3"	FEM 2"1/2		0
020105	BAGUE ALU M4"XF3"	MALE 4"	FEM 3"		0
MALE X MALE					
020129	BAGUE ALU M1"XM1"	MALE 1"	MALE 1"		0
020131	BAGUE ALU M1"1/4XM1"1/4	MALE 1"1/4	MALE 1"1/4		0
020130	BAGUE ALU M1"1/2XM1"	MALE 1"1/2	MALE 1"		0
020128	BAGUE ALU M1"1/2XM1"1/2	MALE 1"1/2	MALE 1"1/2		0
020107	BAGUE ALU M2"XM1"1/2	MALE 2"	MALE 1"1/2		0

Code	Référence	D1	D2	D3	Poids
020127	BAGUE ALU M2"XM2"	MALE 2"	MALE 2"		0
020108	BAGUE ALU M2"1/2XM2"	MALE 2"1/2	MALE 2"		0
020132	BAGUE ALU M2"1/2XM2"1/2	MALE 2"1/2	MALE 2"1/2		0
045343	BAGUE ALU M3"XM2"	MALE 3"	MALE 2"		0
020126	BAGUE ALU M3"XM3"	MALE 3"	MALE 3"		0
020133	BAGUE ALU M4"XM4"	MALE 4"	MALE 4"		0
108177	BAGUE ALU M4"XM2"1/2	MALE 4"	MALE 2"1/2		0

Queue cannelée alu



Queue cannelée alu

Matière : Aluminium

Code	Référence	D1	D2	D3	Poids
020141	QUEUE CANNELEE ALU DN32XM1"1/2	32mm	MALE 1"1/2		0
020142	QUEUE CANNELEE ALU DN50XM2"	50mm	MALE 2"		0
020143	QUEUE CANNELEE ALU DN65X2"1/2	65mm	MALE 2"1/2		0
045340	QUEUE CANNELEE ALU DN76XM3"	76mm	MALE 3"		0
020144	QUEUE CANNELEE ALU DN80XM3"	80mm	MALE 3"		0
020145	QUEUE CANNELEE ALU DN100XM4"	100mm	MALE 4"		0

Bague de sertissage en alu

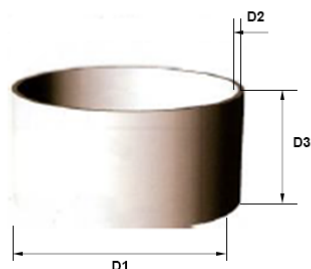

Bague de sertissage en alu

Matière : Aluminium

Code	Référence	D1	D2	D3	Poids
045285	BAGUE ALU A SERTIR 26X2X30	26mm	2mm	30mm	0
045286	BAGUE ALU A SERTIR 31X2X30	31mm	2mm	30mm	0
045284	BAGUE ALU A SERTIR 36X2X30	36mm	2mm	30mm	0
103050	BAGUE ALU A SERTIR 40X2.5X20	40mm	2.5mm	20mm	0
073094	BAGUE ALU A SERTIR 45X2X35	45mm	2mm	35mm	0
020155	BAGUE ALU A SERTIR 46X2X30	46mm	2mm	30mm	0
005717	BAGUE ALU A SERTIR 51X2X30	51mm	2mm	30mm	0
020146	BAGUE ALU A SERTIR 57X2X30	57mm	2mm	30mm	0
018889	BAGUE ALU A SERTIR 60X2X40	60mm	2mm	40mm	0
020147	BAGUE ALU A SERTIR 67X2X30	67mm	2mm	30mm	0
020148	BAGUE ALU A SERTIR 69X2X40	69mm	2mm	40mm	0
005718	BAGUE ALU A SERTIR 76X2X40	76mm	2mm	40mm	0
020149	BAGUE ALU A SERTIR 80X2X30	80mm	2mm	30mm	0
020150	BAGUE ALU A SERTIR 84X2X30	84mm	2mm	30mm	0
020151	BAGUE ALU A SERTIR 88X2.5X45	88mm	2.5mm	45mm	0
115685	BAGUE ALU A SERTIR 90X2X65	90mm	2mm	65mm	0
005719	BAGUE ALU A SERTIR 95X2.5X70	95mm	2.5mm	70mm	0
020152	BAGUE ALU A SERTIR 101X2X65	101mm	2mm	65mm	0
045287	BAGUE ALU A SERTIR 102X2.5X90	102mm	2.5mm	90mm	0
005716	BAGUE ALU A SERTIR 108X2.5X90	108mm	2.5mm	90mm	0
020153	BAGUE ALU A SERTIR 116X2.5X80	116mm	2.5mm	80mm	0
045288	BAGUE ALU A SERTIR 120X2.5X90	120mm	2.5mm	90mm	0
020154	BAGUE ALU A SERTIR 124X2.5X80	124mm	2.5mm	80mm	0

2- RACCORD SYMÉTRIQUE BRONZE



Demi raccord à douille crantée bronze

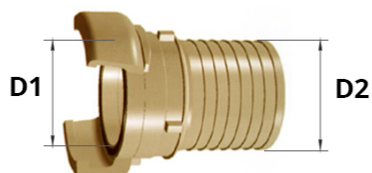

Demi raccord à douille crantée bronze

Matière : Bronze

Code	Référence	D1	D2	Poids
027297	1/2 SYM BZE 20/25	20mm	25mm	0
027296	1/2 SYM BZE 25/30	25mm	30mm	0
027295	1/2 SYM BZE 32/35	32mm	35mm	0
027294	1/2 SYM BZE 40/40	40mm	40mm	0
027293	1/2 SYM BZE 40/45	40mm	45mm	0
000165	1/2 SYM BZE 50/50	50mm	50mm	0
027292	1/2 SYM BZE 50/55	50mm	55mm	0
027298	1/2 SYM BZE 65/65	65mm	65mm	0
027299	1/2 SYM BZE 65/70	65mm	70mm	0
027302	1/2 SYM BZE 80/75	80mm	75mm	0
027300	1/2 SYM BZE 80/80	80mm	80mm	0
027301	1/2 SYM BZE 80/90	80mm	90mm	0
027303	1/2 SYM BZE 100/100	100mm	100mm	0
027304	1/2 SYM BZE 100/110	100mm	110mm	0

Jonction symétrique bronze (avec verrou)

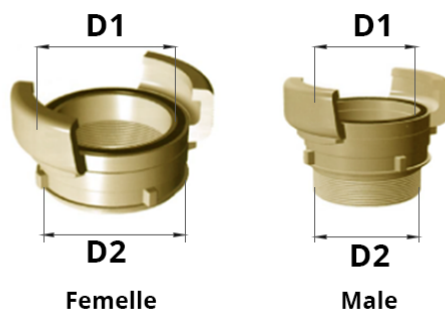

Jonction symétrique bronze (avec verrou)

Matière : Bronze

Code	Référence	D1	D2	Poids
FEMELLE				
027278	JONCT SYM BZE 20F3/4	20mm	FEM 3/4	0
027277	JONCT SYM BZE 25F1"	25mm	FEM 1"	0
027276	JONCT SYM BZE 32F1"1/4	32mm	FEM 1"1/4	0
008745	JONCT SYM BZE 40F1"1/2	40mm	FEM 1"1/2	0
027272	JONCT SYM BZE 50F2"	50mm	FEM 2"	0
008747	JONCT SYM BZE 65F2"1/2	65mm	FEM 2"1/2	0
008749	JONCT SYM BZE 80F3"	80mm	FEM 3"	0
008742	JONCT SYM BZE 100F4"	100mm	FEM 4"	0
MALE				
008744	JONCT SYM BZE 20M3/4	20mm	MALE 3/4	0
027275	JONCT SYM BZE 25M1"	25mm	MALE 1"	0
027274	JONCT SYM BZE 32M1"1/4	32mm	MALE 1"1/4	0
008746	JONCT SYM BZE 40M1"1/2	40mm	MALE 1"1/2	0
027273	JONCT SYM BZE 50M2"	50mm	MALE 2"	0
008748	JONCT SYM BZE 65M2"1/2	65mm	MALE 2"1/2	0
020067	JONCT SYM BZE 80M3"	80mm	MALE 3"	0
008743	JONCT SYM BZE 100M4"	100mm	MALE 4"	0

Boite symétrique bronze (sans verrou)

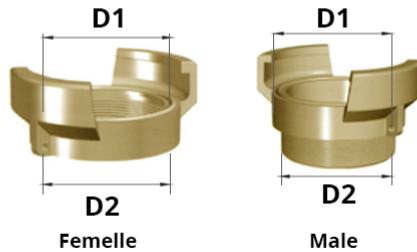

Boite symétrique bronze (sans verrou)

Matière : Bronze

Code	Référence	D1	D2	Poids
FEM				
027291	BOITE SYM BZE 20F3/4	20mm	FEM 3/4	0
027290	BOITE SYM BZE 25F1"	25mm	FEM 1"	0
027289	BOITE SYM BZE 32F1"1/4	32mm	FEM 1"1/4	0
027288	BOITE SYM BZE 40F1"1/2	40mm	FEM 1"1/2	0
027287	BOITE SYM BZE 50F2"	50mm	FEM 2"	0
027261	BOITE SYM BZE 65F2"1/2	65mm	FEM 2"1/2	0
027281	BOITE SYM BZE 80F3"	80mm	FEM 3"	0
005882	BOITE SYM BZE 100F4"	100mm	FEM 4"	0
MALE				
027286	BOITE SYM BZE 20M3/4	20mm	MALE 3/4	0
027285	BOITE SYM BZE 25M1"	25mm	MALE 1"	0
027284	BOITE SYM BZE 32M1"1/4	32mm	MALE 1"1/4	0
027283	BOITE SYM BZE 40M1"1/2	40mm	MALE 1"1/2	0
027282	BOITE SYM BZE 50M2"	50mm	MALE 2"	0
027279	BOITE SYM BZE 65M2"1/2	65mm	MALE 2"1/2	0
027280	BOITE SYM BZE 80M3"	80mm	MALE 3"	0
025915	BOITE SYM BZE 100M4"	100mm	MALE 4"	0

Reduction symétrique bronze

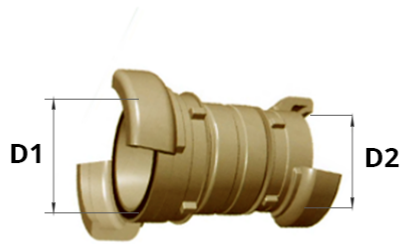

Reduction symétrique bronze

Matière : Bronze

Code	Référence	D1	D2	Poids
027313	REDUC SYM BZE 40/20	40mm	20mm	0
027312	REDUC SYM BZE 40/25	40mm	25mm	0
027311	REDUC SYM BZE 40/32	40mm	32mm	0
010604	REDUC SYM BZE 50/40	50mm	40mm	0
027310	REDUC SYM BZE 65/40	65mm	40mm	0
010605	REDUC SYM BZE 65/50	65mm	50mm	0
027309	REDUC SYM BZE 80/40	80mm	40mm	0
027308	REDUC SYM BZE 80/50	80mm	50mm	0
010606	REDUC SYM BZE 80/65	80mm	65mm	0
027307	REDUC SYM BZE 100/40	100mm	40mm	0
027306	REDUC SYM BZE 100/50	100mm	50mm	0
010603	REDUC SYM BZE 100/65	100mm	65mm	0
027305	REDUC SYM BZE 100/80	100mm	80mm	0

Bouchon symétrique bronze avec/sans verrou



Avec verrou

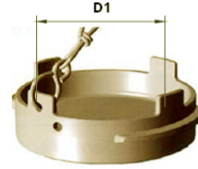

Sans verrou (cadenassable)

Bouchon symétrique bronze avec/sans verrou

Matière : Bronze

Code	Référence	D1	D2	Poids
AVEC VERROU				
027268	BOUCH SYM BZE 20	20mm		0
027267	BOUCH SYM BZE 25	25mm		0
027266	BOUCH SYM BZE 32	32mm		0
027265	BOUCH SYM BZE 40	40mm		0
005908	BOUCH SYM BZE 50	50mm		0
027260	BOUCH SYM BZE 65	65mm		0
027264	BOUCH SYM BZE 80	80mm		0
005907	BOUCH SYM BZE 100	100mm		0
SANS VERROU				
027271	BOUCH SV SYM BZE 40	40mm		0
027270	BOUCH SV SYM BZE 50	50mm		0
027269	BOUCH SV SYM BZE 65	65mm		0
024215	BOUCH SV SYM BZE 80	80mm		0

3- RACCORD SYMÉTRIQUE INOX



Demi raccord à douille crantée inox

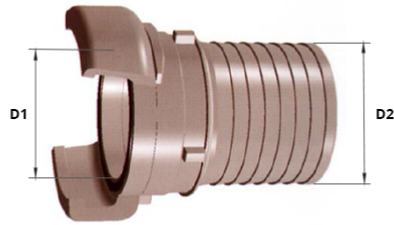

Demi raccord à douille crantée inox

Matière : inox

Code	Référence	D1	D2	D3	Poids
044658	1/2 SYM INOX 20/25	20mm	25mm		0
044659	1/2 SYM INOX 25/30	25mm	30mm		0
044660	1/2 SYM INOX 32/35	32mm	35mm		0
044661	1/2 SYM INOX 40/40	40mm	40mm		0
044662	1/2 SYM INOX 40/45	40mm	45mm		0
000166	1/2 SYM INOX 50/50	50mm	50mm		0
044663	1/2 SYM INOX 50/55	50mm	55mm		0
044664	1/2 SYM INOX 65/65	65mm	65mm		0
044665	1/2 SYM INOX 65/70	65mm	70mm		0
044666	1/2 SYM INOX 80/75	80mm	75mm		0
044668	1/2 SYM INOX 80/80	80mm	80mm		0
044669	1/2 SYM INOX 80/90	80mm	90mm		0
044670	1/2 SYM INOX 100/100	100mm	100mm		0
044671	1/2 SYM INOX 100/110	100mm	110mm		0

Jonction symétrique inox (avec verrou)

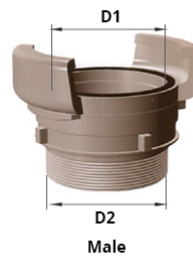
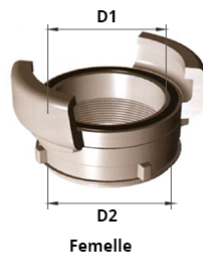

Jonction symétrique inox (avec verrou)

Matière : inox

Code	Référence	D1	D2	D3	Poids
FEMELLE					
044016	JONCT SYM INOX 20F3/4	20mm	FEM 3/4		0
044691	JONCT SYM INOX 25F1"	25mm	FEM 1"		0
044692	JONCT SYM INOX 32F1"1/4	32mm	FEM 1"1/4		0.12
008752	JONCT SYM INOX 40F1"1/2	40mm	FEM 1"1/2		0.18
027155	JONCT SYM INOX 50F2"	50mm	FEM 2"		0
044693	JONCT SYM INOX 65F2"1/2	65mm	FEM 2"1/2		0
008756	JONCT SYM INOX 80F3"	80mm	FEM 3"		0.72
008751	JONCT SYM INOX 100F4"	100mm	FEM 4"		0
MALE					
044017	JONCT SYM INOX 20M3/4	20mm	MALE 3/4		0
044686	JONCT SYM INOX 25M1"	25mm	MALE 1"		0
044687	JONCT SYM INOX 32M1"1/4	32mm	MALE 1"1/4		0
044689	JONCT SYM INOX 40M1"1/2	40mm	MALE 1"1/2		0
008754	JONCT SYM INOX 50M2"	50mm	MALE 2"		0
044694	JONCT SYM INOX 65M2"1/2	65mm	MALE 2"1/2		0
015874	JONCT SYM INOX 80M3"	80mm	MALE 3"		0.84
044690	JONCT SYM INOX 100M4"	100mm	MALE 4"		0

Boite symétrique inox (sans verrou)

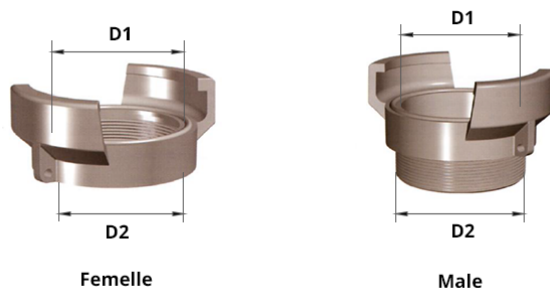

Boite symétrique inox (sans verrou)

Matière : inox

Code	Référence	D1	D2	D3	Poids
FEMELLE					
044703	BOITE SYM INOX 20F3/4	20mm	FEM 3/4		0,07
044704	BOITE SYM INOX 25F1"	25mm	FEM 1"		0
044705	BOITE SYM INOX 32F1"1/4	32mm	FEM 1"1/4		0
044706	BOITE SYM INOX 40F1"1/2	40mm	FEM 1"1/2		0
044707	BOITE SYM INOX 50F2"	50mm	FEM 2"		0
044708	BOITE SYM INOX 65F2"1/2	65mm	FEM 2"1/2		0
036505	BOITE SYM INOX 80F3"	80mm	FEM 3"		0
044709	BOITE SYM INOX 100F4"	100mm	FEM 4"		0
MALE					
044695	BOITE SYM INOX 20M3/4	20mm	MALE 3/4		0
044696	BOITE SYM INOX 25M1"	25mm	MALE 1"		0
044697	BOITE SYM INOX 32M1"1/4	32mm	MALE 1"1/4		0
044698	BOITE SYM INOX 40M1"1/2	40mm	MALE 1"1/2		0
044699	BOITE SYM INOX 50M2"	50mm	MALE 2"		0
044700	BOITE SYM INOX 65M2"1/2	65mm	MALE 2"1/2		0
044701	BOITE SYM INOX 80M3"	80mm	MALE 3"		0
044702	BOITE SYM INOX 100M4"	100mm	MALE 4"		0

Réduction symétrique inox

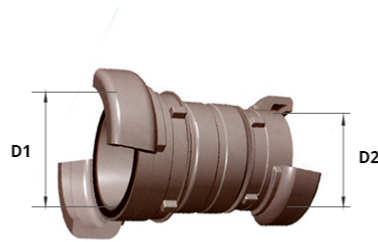

Réduction symétrique inox

Matière : inox

Code	Référence	D1	D2	D3	Poids
044685	REDUC SYM INOX 40/20	40mm	20mm		0
044676	REDUC SYM INOX 40/25	40mm	25mm		0
044677	REDUC SYM INOX 40/32	40mm	32mm		0
044678	REDUC SYM INOX 50/32	50mm	32mm		0
044679	REDUC SYM INOX 50/40	50mm	40mm		0
044331	REDUC SYM INOX 65/40	65mm	40mm		0
044680	REDUC SYM INOX 65/50	65mm	50mm		0
044681	REDUC SYM INOX 80/40	80mm	40mm		0
010608	REDUC SYM INOX 80/50	80mm	50mm		0
044682	REDUC SYM INOX 80/65	80mm	65mm		0
044332	REDUC SYM INOX 100/40	100mm	40mm		0
044683	REDUC SYM INOX 100/50	100mm	50mm		0
044684	REDUC SYM INOX 100/65	100mm	65mm		0
010607	REDUC SYM INOX 100/80	100mm	80mm		0

Bouchon symétrique inox



Avec verrou

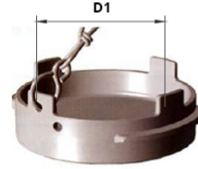

Sans verrou (cadenassable)

Bouchon symétrique inox

Matière : inox

Code	Référence	D1	D2	D3	Poids
AVEC VERROU					
044711	BOUCH SYM INOX 20	20mm			0
037537	BOUCH SYM INOX 25	25mm			0
044713	BOUCH SYM INOX 32	32mm			0.19
005909	BOUCH SYM INOX 40	40mm			0
044714	BOUCH SYM INOX 50	50mm			0
044715	BOUCH SYM INOX 65	65mm			0
036507	BOUCH SYM INOX 80	80mm			1.13
044716	BOUCH SYM INOX 100	100mm			0
SANS VERROU					
005896	BOUCH SV SYM INOX 40	40mm			0
005897	BOUCH SV SYM INOX 50	50mm			0
044710	BOUCH SV SYM INOX 65	65mm			0
005898	BOUCH SV SYM INOX 80	80mm			0
024180	BOUCH SV SYM INOX 100	100mm			0

Bague de sertissage en inox



Bague de sertissage en inox

Matière : Inox
D1 = Diamètre intérieur
D2 = Epaisseur
D3 = Longueur

Code	Référence	D1	D2	D3	Poids
045289	BAGUE INOX A SERTIR 13X1.5X20	13mm	1.5mm	20mm	0
045291	BAGUE INOX A SERTIR 16.5X1.5X20	16.5mm	1.5mm	20mm	0
045292	BAGUE INOX A SERTIR 20.5X1.5X20	20.5mm	1.5mm	20mm	0
045290	BAGUE INOX A SERTIR 24.5X1.5X20	24.5mm	1.5mm	20mm	0
045293	BAGUE INOX A SERTIR 29.5X1.5X25	29.5mm	1.5mm	25mm	0
045294	BAGUE INOX A SERTIR 37X2X25	37mm	2mm	25mm	0
045295	BAGUE INOX A SERTIR 44.5X2X30	44.5mm	2mm	30mm	0
045296	BAGUE INOX A SERTIR 54.5X2X30	54mm	2mm	30mm	0
045297	BAGUE INOX A SERTIR 68X2X35	68mm	2mm	35mm	0
045298	BAGUE INOX A SERTIR 87X2X35	87mm	2mm	35mm	0
109818	BAGUE INOX A SERTIR 87X2X35	87mm	2mm	35mm	0
045299	BAGUE INOX A SERTIR 98.5X2X40	98.5mm	2mm	40mm	0
045300	BAGUE INOX A SERTIR 121X2X50	121mm	2mm	50mm	0
093852	BAGUE INOX A SERTIR 152X2X60	152mm	2mm	60mm	0

4- RACCORD SYMÉTRIQUE POLYPRO



Demi raccord à douille crantée polypropylène



Demi raccord à douille crantée polypropylène

Matière : polypropylène

Code	Référence	D1	D2	Poids
044743	1/2 SYM PP 40/35	40mm	35mm	0
044744	1/2 SYM PP 40/40	40mm	40mm	0
044745	1/2 SYM PP 40/45	40mm	45mm	0
044746	1/2 SYM PP 50/50	50mm	50mm	0
044747	1/2 SYM PP 50/55	50mm	55mm	0
044748	1/2 SYM PP 80/75	80mm	75mm	0
044749	1/2 SYM PP 80/90	80mm	90mm	0
044750	1/2 SYM PP 100/110	100mm	110mm	0

Jonction symétrique polypropylène (avec verrou)

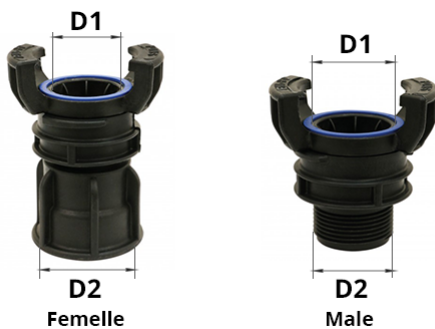

Jonction symétrique polypropylène (avec verrou)

Matière : polypropylène

Code	Référence	D1	D2	Poids
FEMELLE				
044753	JONCT SYM PP 40F1*1/2	40mm	FEM 1*1/2	0
008757	JONCT SYM PP 50F2"	50mm	FEM 2"	0
044754	JONCT SYM PP 80F3"	80mm	FEM 3"	0
044755	JONCT SYM PP 100F4"	100mm	FEM 4"	0
MALE				
044751	JONCT SYM PP 40M1*1/2	40mm	MALE 1*1/2	0
008758	JONCT SYM PP 50M2"	50mm	MALE 2"	0
008759	JONCT SYM PP 80M3"	80mm	MALE 3"	0
044752	JONCT SYM PP 100M4"	100mm	MALE 4"	0

Bouchon symétrique sans verrou polypropylène



Bouchon symétrique sans verrou polypropylène
(cadenassable)

Matière : polypropylène

Code	Référence	D1	D2	Poids
044756	BOUCH SV SYM PP 40	40mm		0
044757	BOUCH SV SYM PP 50	50mm		0
044758	BOUCH SV SYM PP 80	80mm		0
044759	BOUCH SV SYM PP 100	100mm		0

5- ACCESSOIRES POUR RACCORD SYMÉTRIQUE



Clés tricoises et diverses

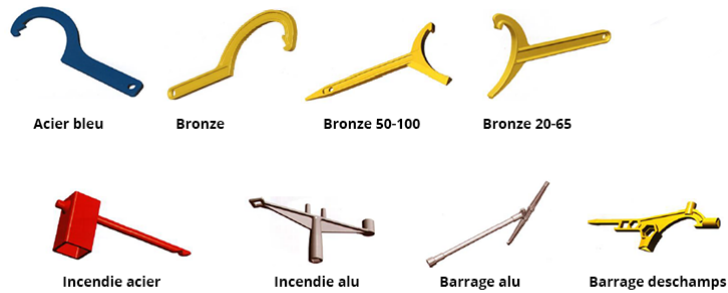

Clés tricoises et diverses

Code	Référence	D1	D2	Poids
006508	CLE TRICOISE ACIER ROUGE			0
006500	CLE TRICOISE ACIER BLEU (RENFORCEE)			0
006510	CLE TRICOISE BZE 20/65			0
006511	CLE TRICOISE BZE 20/120			0
006502	CLE TRICOISE "DESCHAMPS"			0
100517	CLE TRICOISE ACIER DOUBLE 20+150			0
100518	CLE TRICOISE ACIER 20+150 ARTICULEE			0
006506	CLE POTEAU D'INCENDIE ACIER ROUGE			0
006509	CLE TRICOISE BRONZE 50/100			0
035102	CLE POTEAU D'INCENDIE ALU			0
006501	CLE DE BARRAGE ALU STANDARD			0
035105	CLE DE BARRAGE ALU LG 1,50M			0

Joint NBR pour raccord symétrique



Joint NBR pour raccord symétrique

Matière : NBR

Code	Référence	D1	D2	Poids
008699	JOINT SYM NBR 20	20mm		0
008700	JOINT SYM NBR 25	25mm		0
008701	JOINT SYM NBR 32	32mm		0
008702	JOINT SYM NBR 40	40mm		0
008703	JOINT SYM NBR 50	50mm		0
008704	JOINT SYM NBR 65	65mm		0
008705	JOINT SYM NBR 80	80mm		0
008698	JOINT SYM NBR 100	100mm		0
086991	JOINT SYM NBR 125	125mm		0
079810	JOINT SYM NBR 150	150mm		0
066207	JOINT BOUCH P. SYM NBR 50	50mm		0
066208	JOINT BOUCH P. SYM NBR 80	80mm		0
066205	JOINT BOUCH P. SYM NBR 100	100mm		0

Joint EPDM pour raccord symétrique



Joint EPDM pour raccord symétrique

Matière : EPDM

Code	Référence	D1	D2	Poids
044738	JOINT SYM EPDM 20	20mm		0
037539	JOINT SYM EPDM 25	25mm		0
044739	JOINT SYM EPDM 32	32mm		0
037538	JOINT SYM EPDM 40	40mm		0
044718	JOINT SYM EPDM 50	50mm		0
044719	JOINT SYM EPDM 65	65mm		0
044720	JOINT SYM EPDM 80	80mm		0
044721	JOINT SYM EPDM 100	100mm		0

Joint viton pour raccord symétrique



Joint viton pour raccord symétrique

Matière : Viton

Code	Référence	D1	D2	Poids
044722	JOINT SYM VITON 20	20mm		0
044723	JOINT SYM VITON 25	25mm		0
044724	JOINT SYM VITON 32	32mm		0
044725	JOINT SYM VITON 40	40mm		0
044726	JOINT SYM VITON 50	50mm		0
044727	JOINT SYM VITON 65	65mm		0
044728	JOINT SYM VITON 80	80mm		0
044729	JOINT SYM VITON 100	100mm		0

Joint PTFE pour raccord symétrique



Joint PTFE pour raccord symétrique

Matière : PTFE

Code	Référence	D1	D2	Poids
044730	JOINT SYM PTFE 20	20mm		0
044731	JOINT SYM PTFE 25	25mm		0
044732	JOINT SYM PTFE 32	32mm		0
044733	JOINT SYM PTFE 40	40mm		0
044734	JOINT SYM PTFE 50	50mm		0
044735	JOINT SYM PTFE 65	65mm		0
044736	JOINT SYM PTFE 80	80mm		0
044737	JOINT SYM PTFE 100	100mm		0

6- RACCORD STORZ



Demi raccord STORZ à douille crantée alu



Demi raccord STORZ à douille crantée alu

Matière : Aluminium
Pression nominale de service : 16 bars

Code	Référence	D1	D2	Poids
044800	1/2 STZ ALU 25/19	25mm	19mm	0
027314	1/2 STZ ALU 25/25	25mm	25mm	0.09
027317	1/2 STZ ALU 38/38	38mm	38mm	0.22
027318	1/2 STZ ALU 52/19	52mm	19mm	0
027319	1/2 STZ ALU 52/25	52mm	25mm	0
027320	1/2 STZ ALU 52/32	52mm	32mm	0
027321	1/2 STZ ALU 52/38	52mm	38mm	0
027322	1/2 STZ ALU 52/42	52mm	42mm	0
027323	1/2 STZ ALU 52/45	52mm	45mm	0
027324	1/2 STZ ALU 52/51	52mm	51mm	0.37
027325	1/2 STZ ALU 52/60	52mm	60mm	0
027326	1/2 STZ ALU 65/51	65mm	61mm	0
027327	1/2 STZ ALU 65/65	65mm	65mm	0
027328	1/2 STZ ALU 65/76	65mm	76mm	0
027329	1/2 STZ ALU 75/51	75mm	51mm	0
027330	1/2 STZ ALU 75/65	75mm	65mm	0
092795	1/2 STZ ALU 75/70	75mm	70mm	0
027331	1/2 STZ ALU 75/76	75mm	76mm	0.71
027332	1/2 STZ ALU 75/80	75mm	80mm	0
027333	1/2 STZ ALU 100/100	100mm	100mm	1.66
027334	1/2 STZ ALU 110/90	110mm	90mm	0
027335	1/2 STZ ALU 110/100	110mm	100mm	0
027336	1/2 STZ ALU 110/110	110mm	110mm	0
027337	1/2 STZ ALU 125/125	125mm	125mm	0

Jonction femelle/male STORZ

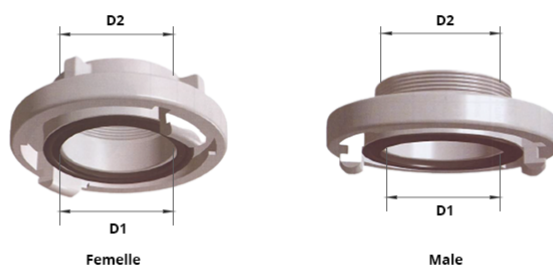

Jonction femelle/male STORZ

Matière : Aluminium
Pression nominale de service : 16 bars

Code	Référence	D1	D2	Poids
FEMELLE				
008711	JONCT STZ ALU 25F3/4	25mm	FEM 3/4	0
008712	JONCT STZ ALU 25F1"	25mm	FEM 1"	0.08
008760	JONCT STZ ALU 32F1"1/4	32mm	FEM 1"1/4	0
027351	JONCT STZ ALU 32F1"	32mm	FEM 1"	0
027352	JONCT STZ ALU 38F1"1/4	38mm	FEM 1"1/4	0
027353	JONCT STZ ALU 38F1"1/2	38mm	FEM 1"1/2	0.16
027354	JONCT STZ ALU 38F2"	38mm	FEM 2"	0
027355	JONCT STZ ALU 52F1"	52mm	FEM 1"	0
027356	JONCT STZ ALU 52F1"1/4	52mm	FEM 1"1/4	0
019219	JONCT STZ ALU 52F1"1/2	52mm	FEM 1"1/2	0
019220	JONCT STZ ALU 52F2"	52mm	FEM 2"	0.26
027357	JONCT STZ ALU 52F2"1/2	52mm	FEM 2"1/2	0
027358	JONCT STZ ALU 65F2"	65mm	FEM 2"	0
027359	JONCT STZ ALU 65F2"1/2	65mm	FEM 2"1/2	0
027360	JONCT STZ ALU 65F3"	65mm	FEM 3"	0
008714	JONCT STZ ALU 75F2"	75mm	FEM 2"	0
027362	JONCT STZ ALU 75F2"1/2	75mm	FEM 2"1/2	0
008715	JONCT STZ ALU 75F3"	75mm	FEM 3"	0.42
027363	JONCT STZ ALU 100F4"	100mm	FEM 4"	0
027364	JONCT STZ ALU 110F4"	110mm	FEM 4"	1.26
027365	JONCT STZ ALU 110F4"1/2	110mm	FEM 4"1/2	0
027366	JONCT STZ ALU 125F4"	125mm	FEM 4"	0
027367	JONCT STZ ALU 125F5"	125mm	FEM 5"	0
027368	JONCT STZ ALU 150F6"	150mm	FEM 6"	0
MALE				
027369	JONCT STZ ALU 25M3/4	25mm	MALE 3/4	0
027370	JONCT STZ ALU 25M1"	25mm	MALE 1"	0.07
027371	JONCT STZ ALU 32M1"	32mm	MALE 1"	0
027372	JONCT STZ ALU 38M1"1/4	38mm	MALE 1"1/4	0
027373	JONCT STZ ALU 38M1"1/2	38mm	MALE 1"1/2	0.14
027374	JONCT STZ ALU 52M1"	52mm	MALE 1"	0
027375	JONCT STZ ALU 52M1"1/4	52mm	MALE 1"1/4	0
027376	JONCT STZ ALU 52M1"1/2	52mm	MALE 1"1/2	0
027377	JONCT STZ ALU 52M2"	52mm	MALE 2"	0.21
027378	JONCT STZ ALU 52M2"1/2	52mm	MALE 2"1/2	0
027379	JONCT STZ ALU 65M1"1/2	65mm	MALE 1"1/2	0
027380	JONCT STZ ALU 65M2"	65mm	MALE 2"	0

Code	Référence	D1	D2	Poids
027381	JONCT STZ ALU 65M2"1/2	65mm	MALE 2"1/2	0.37
027382	JONCT STZ ALU 65M3"	65mm	MALE 3"	0
008716	JONCT STZ ALU 75M2"1/2	75mm	MALE 2"1/2	0
027383	JONCT STZ ALU 75M2"	75mm	MALE 2"	0
027384	JONCT STZ ALU 75M3"	75mm	MALE 3"	0.39
027385	JONCT STZ ALU 100M4"	100mm	MALE 4"	0
027386	JONCT STZ ALU 110M4"	110mm	MALE 4"	0.98
027387	JONCT STZ ALU 125M5"	125mm	MALE 5"	0
027388	JONCT STZ ALU 150M6"	150mm	MALE 6"	0

Jonction tournant femelle STORZ

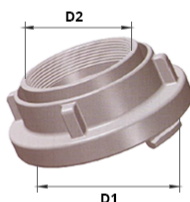

Jonction tournant femelle STORZ

Matière : Aluminium
Pression nominale de service : 16 bars

Code	Référence	D1	D2	Poids
FEMELLE				
008713	JONCT STZ ALU 52FT2"	52mm	FEM 2"	0
027413	JONCT STZ ALU 65FT2"1/2	65mm	FEM 2"1/2	0
027392	JONCT STZ ALU 75FT3"	75mm	FEM 3"	0
027393	JONCT STZ ALU 100FT4"	100mm	FEM 4"	0
027394	JONCT STZ ALU 110FT4"	110mm	FEM 4"	0

Bouchon STORZ

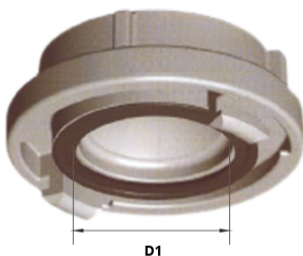

Bouchon STORZ

Matière : aluminium

Code	Référence	D1	D2	Poids
027418	BOUCH STZ ALU 25	25mm		0.09
027419	BOUCH STZ ALU 32	32mm		0
027420	BOUCH STZ ALU 38	38mm		0.3
027421	BOUCH STZ ALU 52	52mm		0.38
027422	BOUCH STZ ALU 65	65mm		0.46
005895	BOUCH STZ ALU 75	75mm		0.59
027424	BOUCH STZ ALU 100	100mm		0
027425	BOUCH STZ ALU 110	110mm		1.34
027426	BOUCH STZ ALU 125	125mm		0
027427	BOUCH STZ ALU 150	150mm		0

Réduction STORZ alu

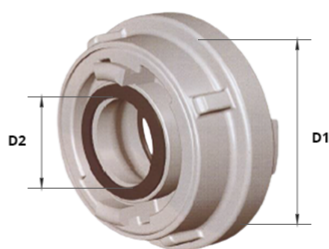

Réduction STORZ alu

Matière : Aluminium
Pression nominale de service : 16 bars

Code	Référence	D1	D2	Poids
027339	REDUC STZ ALU 38/25	38mm	25mm	0
027340	REDUC STZ ALU 52/25	52mm	25mm	0.42
027341	REDUC STZ ALU 52/32	52mm	32mm	0
027342	REDUC STZ ALU 52/38	52mm	38mm	0
027343	REDUC STZ ALU 65/52	65mm	52mm	0
027344	REDUC STZ ALU 75/52	75mm	52mm	0.6
027345	REDUC STZ ALU 75/65	75mm	65mm	0
027346	REDUC STZ ALU 100/75	100mm	75mm	0
027347	REDUC STZ ALU 110/75	110mm	75mm	1.85
027348	REDUC STZ ALU 110/100	110mm	100mm	0
027349	REDUC STZ ALU 125/110	125mm	110mm	0
027350	REDUC STZ ALU 150/110	150mm	110mm	0

Joint pour raccord et clé STORZ



Joint

Clé

Joint pour raccord et clé STORZ

Code	Référence	D1	D2	Poids
027428	JOINT STZ 25	25mm		0
027429	JOINT STZ 32	32mm		0
027430	JOINT STZ 38	38mm		0
027431	JOINT STZ 52	52mm		0
027432	JOINT STZ 65	65mm		0
027433	JOINT STZ 75	75mm		0
027434	JOINT STZ 100	100mm		0
027435	JOINT STZ 110	110mm		0
027436	JOINT STZ 125	125mm		0
027437	JOINT STZ 150	150mm		0
CLE				
035103	CLE STORZ 52/75			0
035104	CLE STORZ 75/110			0

7- RACCORD EXPRESS ET COLLIERS



Raccord express à queue cannelée

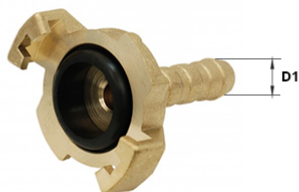

Raccord express à queue cannelée
(avec joint NBR grand trou monté)

Matière : laiton

Code	Référence	D1	D2	Poids
007368	EXPRESS D 6	6mm		0
035095	EXPRESS D 8	8mm		0
007360	EXPRESS D10	10mm		0
007361	EXPRESS D13	13mm		0
007362	EXPRESS D16	16mm		0
007363	EXPRESS D19	19mm		0
007365	EXPRESS D25	25mm		0
007367	EXPRESS D32	32mm		0

Raccord express femelle ou male



Raccord express femelle/male
(avec joint NBR grand trou monté)

Matière : laiton

Code	Référence	D1	D2	Poids
FEMELLE				
007373	EXPRESS F1/4	FEM 1/4		0
007377	EXPRESS F3/8	FEM 3/8		0
007371	EXPRESS F1/2	FEM 1/2		0
007374	EXPRESS F3/4	FEM 3/4		0
007369	EXPRESS F1"	FEM 1"		0
007370	EXPRESS F1"1/4	FEM 1"1/4		0
MALE				
007383	EXPRESS M1/4	MALE 1/4		0
007387	EXPRESS M3/8	MALE 3/8		0
007381	EXPRESS M1/2	MALE 1/2		0
007384	EXPRESS M3/4	MALE 3/4		0
007378	EXPRESS M1"	MALE 1"		0

Bouchon pour raccord express

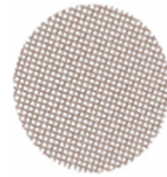

Tamis

Bouchon pour raccord express
(avec joint NBR grand trou monté)

Matière : laiton

Code	Référence	D1	D2	Poids
007358	EXPRESS BOUCHON			0
012780	EXPRESS TAMIS			0

Collier pour raccord express



D1 : Diamètre mini
D2 : Diamètre mani

Collier pour raccord express

D1 : diamètre mini
D2 : diamètre maxi

Code	Référence	D1	D2	Poids
006645	COLLIER EXPRESS 16/18	16mm	18mm	0
006646	COLLIER EXPRESS 19/21	19mm	21mm	0.04
006647	COLLIER EXPRESS 22/24	22mm	24mm	0.04
006648	COLLIER EXPRESS 25/27	25mm	27mm	0.05
006649	COLLIER EXPRESS 28/30	28mm	30mm	0.06
006650	COLLIER EXPRESS 31/33	31mm	33mm	0.08
006651	COLLIER EXPRESS 34/37	34mm	37mm	0.1
006652	COLLIER EXPRESS 37/39	37mm	39mm	0.15

Raccord express inox à queue cannelée



Raccord express inox à queue cannelée
(avec joint NBR grand trou monté)

Matière : inox

Code	Référence	D1	D2	Poids
122569	EXPRESS D 9 INOX	9mm		0
045239	EXPRESS D13 INOX	13mm		0
045240	EXPRESS D16 INOX	16mm		0
045241	EXPRESS D19 INOX	19mm		0
007366	EXPRESS D25 INOX	25mm		0

Raccord express inox male ou femelle



Raccord express inox male ou femelle
(avec joint NBR grand trou monté)

Matière : inox

Code	Référence	D1	D2	Poids
FEMELLE				
045244	EXPRESS F3/8 INOX	FEM 3/8		0
045245	EXPRESS F1/2 INOX	FEM 1/2		0
007376	EXPRESS F3/4 INOX	FEM 3/4		0
045246	EXPRESS F1" INOX	FEM 1"		0
MALE				
045242	EXPRESS M3/8 INOX	MALE 3/8		0
045243	EXPRESS M1/2 INOX	MALE 1/2		0
007386	EXPRESS M3/4 INOX	MALE 3/4		0
007379	EXPRESS M1" INOX	MALE 1"		0

Bouchon inox



Bouchon inox
(avec joint NBR grand trou monté)

Matière : inox

Code	Référence	D1	D2	Poids
007359	EXPRESS BOUCHON INOX			0

Joint pour raccord express



Joint pour raccord express
(avec NBR noir/en FKM marron)

Code	Référence	D1	D2	Poids
008767	EXPRESS JOINT NBR GRAND TROU	NBR		0
018129	EXPRESS JOINT NBR PETIT TROU	NBR		0
122508	EXPRESS JOINT NEO GRAND TROU	NEOPRENE		0
122509	EXPRESS JOINT NEO PETIT TROU	NEOPRENE		0
020000	EXPRESS JOINT VITON	VITON		0

Raccord express fonte queue cannelée

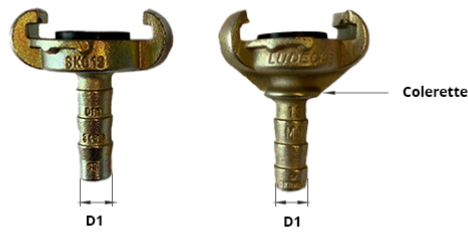

Sans colerette

Avec colerette

Raccord express fonte queue cannelée
(avec joint perbunan monté)

Matière : Acier/Fonte
Avec colerette (d'accrochement) et sans colerette

Code	Référence	D1	D2	Poids
AVEC COLERETTE				
100976	EXPRESS DC13 FONTE	13mm		0
077432	EXPRESS DC19 FONTE	19mm		0
100977	EXPRESS DC25 FONTE	25mm		0
SANS COLERETTE				
020538	EXPRESS D 6 FONTE	6mm		0
020540	EXPRESS D10 FONTE	10mm		0
020541	EXPRESS D13 FONTE	13mm		0
020542	EXPRESS D16 FONTE	16mm		0
007364	EXPRESS D19 FONTE	19mm		0
020543	EXPRESS D25 FONTE	25mm		0
020544	EXPRESS D32 FONTE	32mm		0

Raccord express fonte male ou femelle



Femelle

Male

Raccord express fonte male ou femelle
(avec joint perbunan monté)

Matière : Acier/fonte

Code	Référence	D1	D2	Poids
FEM				
020547	EXPRESS F1/4 FONTE	FEM 1/4		0
020548	EXPRESS F3/8 FONTE	FEM 3/8		0
007372	EXPRESS F1/2 FONTE	FEM 1/2		0
007375	EXPRESS F3/4 FONTE	FEM 3/4		0
020545	EXPRESS F1" FONTE	FEM 1"		0
020546	EXPRESS F1"1/4 FONTE	FEM 1"1/4		0
MALE				
020553	EXPRESS M1/4 FONTE	MALE 1/4		0
020554	EXPRESS M3/8 FONTE	MALE 3/8		0
007382	EXPRESS M1/2 FONTE	MALE 1/2		0
007385	EXPRESS M3/4 FONTE	MALE 3/4		0
020551	EXPRESS M1" FONTE	MALE 1"		0
020552	EXPRESS M1"1/4 FONTE	MALE 1"1/4		0

Bouchon pour raccord express fonte



Bouchon pour raccord express
(avec joint perbunan monté)

Matière : Acier/fonte

Code	Référence	D1	D2	Poids
020555	EXPRESS BOUCHON FONTE			0

Joint pour raccord express fonte



Joint pour raccord express fonte

Code	Référence	D1	D2	Poids
020556	EXPRESS JOINT/FONTE PERBUNAN			0
020557	EXPRESS JOINT/FONTE VAPEUR (OHASIL)			0
020558	EXPRESS JOINT/FONTE VITON			0
102695	EXPRESS JOINT/FONTE MODY NBR			0

8- RACCORD GEKA



Raccord geka queue cannelée



Raccord geka queue cannelée
(avec joint montée)

Matière : laiton

Code	Référence	D1	D2	Poids
018133	GEKA D10	10mm		0.08
007996	GEKA D13	13mm		0.08
007997	GEKA D16	16mm		0.08
007998	GEKA D19	19mm		0.09
007999	GEKA D25	25mm		0.1
008000	GEKA D32	32mm		0.14
008001	GEKA D38	38mm		0.18

Raccord geka male ou femelle

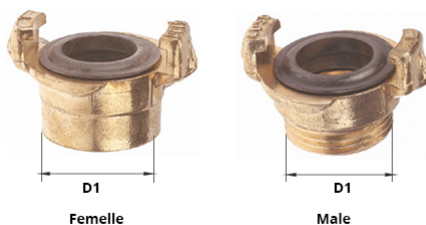

Raccord geka male/femelle
(avec joint montée)

Matière : laiton

Code	Référence	D1	D2	Poids
FEM				
015179	GEKA F1/4	FEM 1/4		0
008007	GEKA F3/8	FEM 3/8		0.08
008005	GEKA F1/2	FEM 1/2		0.08
008006	GEKA F3/4	FEM 3/4		0.08
008002	GEKA F1"	FEM 1"		0.08
008004	GEKA F1"1/4	FEM 1"1/4		0.12
008003	GEKA F1"1/2	FEM 1"1/2		0.14
MALE				
015180	GEKA M1/4	MALE 1/4		0
008013	GEKA M3/8	MALE 3/8		0.08
008011	GEKA M1/2	MALE 1/2		0.08
008012	GEKA M3/4	MALE 3/4		0.08
008008	GEKA M1"	MALE 1"		0.09
008010	GEKA M1"1/4	MALE 1"1/4		0.12
008009	GEKA M1"1/2	MALE 1"1/2		0.13

Bouchon et joint geka



Bouchon et joint geka
(Bouchon avec joint monté)

Matière : laiton

Code	Référence	D1	D2	Poids
007994	GEKA BOUCHON			0.08
015181	GEKA JOINT			0

9- RACCORD À CAME ALUMINIUM



Adapteur male douille annelée alu



Adapteur male annelée alu

Matière : Aluminium

Code	Référence	D1	D2	Poids
028466	CAME MALE ALU 1/2D13	MALE 1/2	13mm	0.03
028467	CAME MALE ALU 3/4D19	MALE 3/4	19mm	0.05
028468	CAME MALE ALU 1D25	MALE 1"	25mm	0.09
028469	CAME MALE ALU 1"1/4D32	MALE 1"1/4	32mm	0.14
028470	CAME MALE ALU 1"1/2D40	MALE 1"1/2	40mm	0.18
028471	CAME MALE ALU 2D50	MALE 2"	50mm	0.25
028472	CAME MALE ALU 2"1/2D63	MALE 2"1/2	63mm	0.45
028473	CAME MALE ALU 3D75	MALE 3"	75mm	0.52
028474	CAME MALE ALU 4D100	MALE 4"	100mm	0.82
028475	CAME MALE ALU 5D125	MALE 5"	125mm	0
028476	CAME MALE ALU 6D150	MALE 6"	150mm	0
044825	CAME MALE ALU 8D200	MALE 8"	200mm	0

Adapteur taraudé femelle alu



Adapteur taraudé femelle alu

Matière : Aluminium

Code	Référence	D1	D2	Poids
028510	CAME MALE ALU 1/2F1/2	MALE 1/2	FEM 1/2	0.02
028511	CAME MALE ALU 3/4F3/4	MALE 3/4	FEM 3/4	0.04
028512	CAME MALE ALU 1F1"	MALE 1"	FEM 1"	0.06
028513	CAME MALE ALU 1"1/4F1"1/4	MALE 1"1/4	FEM 1"1/4	0.09
028514	CAME MALE ALU 1"1/2F1"1/2	MALE 1"1/2	FEM 1"1/2	0.12
028515	CAME MALE ALU 2F2"	MALE 2"	FEM 2"	0.14
021418	CAME MALE ALU 2"1/2F2"1/2	MALE 2"1/2	FEM 2"1/2	0.31
028516	CAME MALE ALU 3F3"	MALE 3"	FEM 3"	0.27
028517	CAME MALE ALU 4F4"	MALE 4"	FEM 4"	0.48
028518	CAME MALE ALU 5F5"	MALE 5"	FEM 5"	0
028519	CAME MALE ALU 6F6"	MALE 6"	FEM 6"	0
044857	CAME MALE ALU 8F8"	MALE 8"	FEM 8"	0

Adapteur fileté male alu



Adapteur fileté male alu

Matière : Aluminium

Code	Référence	D1	D2	Poids
028487	CAME MALE ALU 1/2M1/2	MALE 1/2	MALE 1/2	0.09
028488	CAME MALE ALU 3/4M3/4	MALE 3/4	MALE 3/4	0.12
028489	CAME MALE ALU 1M1"	MALE 1"	MALE 1"	0.16
028490	CAME MALE ALU 1"1/4M1"1/4	MALE 1"1/4	MALE 1"1/4	0.22
028491	CAME MALE ALU 1"1/2M1"1/2	MALE 1"1/2	MALE 1"1/2	0.35
028492	CAME MALE ALU 2M2"	MALE 2"	MALE 2"	0.48
028493	CAME MALE ALU 2"1/2M2"1/2	MALE 2"1/2	MALE 2"1/2	0.73
028494	CAME MALE ALU 3M3"	MALE 3"	MALE 3"	0.87
028495	CAME MALE ALU 4M4"	MALE 4"	MALE 4"	0.79
028496	CAME MALE ALU 5M5"	MALE 5"	MALE 5"	0
028497	CAME MALE ALU 6M6"	MALE 6"	MALE 6"	0
044826	CAME MALE ALU 8M8"	MALE 8"	MALE 8"	0

Bouchon coupleur male



Bouchon coupleur male

Matière : Aluminium

Code	Référence	D1	D2	Poids
028532	BOUCH CAME ALU MALE 1/2	MALE 1/2		0.02
028533	BOUCH CAME ALU MALE 3/4	MALE 3/4		0.029
028534	BOUCH CAME ALU MALE 1"	MALE 1"		0.054
028535	BOUCH CAME ALU MALE 1"1/4	MALE 1"1/4		0.082
028536	BOUCH CAME ALU MALE 1"1/2	MALE 1"1/2		0.104
028537	BOUCH CAME ALU MALE 2"	MALE 2"		0.176
028538	BOUCH CAME ALU MALE 2"1/2	MALE 2"1/2		0.23
028539	BOUCH CAME ALU MALE 3"	MALE 3"		0.256
028540	BOUCH CAME ALU MALE 4"	MALE 4"		0.43
028541	BOUCH CAME ALU MALE 5"	MALE 5"		0
028542	BOUCH CAME ALU MALE 6"	MALE 6"		0
044866	BOUCH CAME ALU MALE 8"	MALE 8"		0

Coupleur femelle douille annelée alu



Coupleur femelle douille annelée alu

Matière : Aluminium

Code	Référence	D1	D2	Poids
028455	CAME FEM ALU 1/2D13	FEM 1/2	13mm	0.07
028456	CAME FEM ALU 3/4D19	FEM 3/4	19mm	0.1
028457	CAME FEM ALU 1D25	FEM 1"	25mm	0.15
028458	CAME FEM ALU 1"1/4D32	FEM 1"1/4	32mm	0.237
028459	CAME FEM ALU 1"1/2D40	FEM 1"1/2	40mm	0.289
028460	CAME FEM ALU 2D50	FEM 2"	50mm	0.38
028461	CAME FEM ALU 2"1/2D63	FEM 2"1/2	63mm	0.489
028462	CAME FEM ALU 3D75	FEM 3"	75mm	0.728
028463	CAME FEM ALU 4D100	FEM 4"	100mm	1.082
028464	CAME FEM ALU 5D125	FEM 5"	125mm	0
028465	CAME FEM ALU 6D150	FEM 6"	150mm	0
044823	CAME FEM ALU 8D200	FEM 8"	200mm	0

Coupleur taraudé femelle alu



Coupleur taraudé femelle alu

Matière : Aluminium

Code	Référence	D1	D2	Poids
028498	CAME FEM ALU 1/2F1/2	FEM 1/2	FEM 1/2	0.072
028499	CAME FEM ALU 3/4F3/4	FEM 3/4	FEM 3/4	0.098
028500	CAME FEM ALU 1F1"	FEM 1"	FEM 1"	0.147
028501	CAME FEM ALU 1"1/4F1"1/4	FEM 1"1/4	FEM 1"1/4	0.233
028502	CAME FEM ALU 1"1/2F1"1/2	FEM 1"1/2	FEM 1"1/2	0.272
028503	CAME FEM ALU 2F2"	FEM 2"	FEM 2"	0.306
028504	CAME FEM ALU 2"1/2F2"1/2	FEM 2"1/2	FEM 2"1/2	0.404
028505	CAME FEM ALU 3F3"	FEM 3"	FEM 3"	0.599
028506	CAME FEM ALU 4F4"	FEM 4"	FEM 4"	0.963
028507	CAME FEM ALU 5F5"	FEM 5"	FEM 5"	0
028508	CAME FEM ALU 6F6"	FEM 6"	FEM 6"	0
044853	CAME FEM ALU 8F8"	FEM 8"	FEM 8"	0

Coupleur fileté male alu



Coupleur fileté male alu

Matière : Aluminium

Code	Référence	D1	D2	Poids
021419	CAME FEM ALU 1"1/2M1"1/2	FEM 1"1/2	MALE 1"1/2	0.233
028477	CAME FEM ALU 1/2M1/2	FEM 1/2	MALE 1/2	0.066
028478	CAME FEM ALU 3/4M3/4	FEM 3/4	MALE 3/4	0.095
028479	CAME FEM ALU 1M1"	FEM 1"	MALE 1"	0.135
028480	CAME FEM ALU 1"1/4M1"1/4	FEM 1"1/4	MALE 1"1/4	0.221
028481	CAME FEM ALU 2M2"	FEM 2"	MALE 2"	0.276
028482	CAME FEM ALU 2"1/2M2"1/2	FEM 2"1/2	MALE 2"1/2	0.391
028483	CAME FEM ALU 3M3"	FEM 3"	MALE 3"	0.564
028484	CAME FEM ALU 4M4"	FEM 4"	MALE 4"	0.861
028485	CAME FEM ALU 5M5"	FEM 5"	MALE 5"	0
028486	CAME FEM ALU 6M6"	FEM 6"	MALE 6"	0
044824	CAME FEM ALU 8M8"	FEM 8"	MALE 8"	0

Bouchon coupleur femelle



Bouchon coupleur femelle

Matière : Aluminium

Code	Référence	D1	D2	Poids
028520	BOUCH CAME ALU FEM 1/2	FEM 1/2		0.07
028521	BOUCH CAME ALU FEM 3/4	FEM 3/4		0.082
028522	BOUCH CAME ALU FEM 1"	FEM 1"		0.116
028523	BOUCH CAME ALU FEM 1"1/4	FEM 1"1/4		0.211
028524	BOUCH CAME ALU FEM 1"1/2	FEM 1"1/2		0.218
028525	BOUCH CAME ALU FEM 2"	FEM 2"		0.276
028526	BOUCH CAME ALU FEM 2"1/2	FEM 2"1/2		0.341
028527	BOUCH CAME ALU FEM 3"	FEM 3"		0.566
028529	BOUCH CAME ALU FEM 4"	FEM 4"		0.742
028530	BOUCH CAME ALU FEM 5"	FEM 5"		0
028531	BOUCH CAME ALU FEM 6"	FEM 6"		0
044865	BOUCH CAME ALU FEM 8"	FEM 8"		0

10- RACCORD CAME LAITON



Adaptateur male douille annelée laiton



Adaptateur male annelée laiton

Matière : laiton

Code	Référence	D1	D2	Poids
028656	CAME MALE LAIT 1/2D13	MALE 1/2	13mm	0.1
028657	CAME MALE LAIT 3/4D19	MALE 3/4	19mm	0.15
028658	CAME MALE LAIT 1D25	MALE 1"	25mm	0.168
028659	CAME MALE LAIT 1"1/4D32	MALE 1"1/4	32mm	0.285
028660	CAME MALE LAIT 1"1/2D40	MALE 1"1/2	40mm	0.48
028661	CAME MALE LAIT 2D50	MALE 2"	50mm	0.57
006256	CAME MALE LAIT 2"1/2D63	MALE 2"1/2	63mm	0.797
028662	CAME MALE LAIT 3D75	MALE 3"	75mm	1.189
028663	CAME MALE LAIT 4D100	MALE 4"	100mm	1.902
028664	CAME MALE LAIT 5D125	MALE 5"	125mm	0
028665	CAME MALE LAIT 6D150	MALE 6"	150mm	0

Adaptateur taraudé femelle laiton



Adaptateur taraudé femelle laiton

Matière : laiton

Code	Référence	D1	D2	Poids
028647	CAME MALE LAIT 1/2F1/2	MALE 1/2	FEM 1/2	0.047
028648	CAME MALE LAIT 3/4F3/4	MALE 3/4	FEM 3/4	0.108
022982	CAME MALE LAIT 1F1"	MALE 1"	FEM 1"	0.138
028649	CAME MALE LAIT 1"1/4F1"1/4	MALE 1"1/4	FEM 1"1/4	0.195
028650	CAME MALE LAIT 1"1/2F1"1/2	MALE 1"1/2	FEM 1"1/2	0.277
028651	CAME MALE LAIT 2F2"	MALE 2"	FEM 2"	0
028652	CAME MALE LAIT 2"1/2F2"1/2	MALE 2"1/2	FEM 2"1/2	0.5
019978	CAME MALE LAIT 3F3"	MALE 3"	FEM 3"	0.674
028653	CAME MALE LAIT 4F4"	MALE 4"	FEM 4"	0
028654	CAME MALE LAIT 5F5"	MALE 5"	FEM 5"	0
028655	CAME MALE LAIT 6F6"	MALE 6"	FEM 6"	0

Adapteur fileté male laiton



Adapteur fileté male laiton

Matière : laiton

Code	Référence	D1	D2	Poids
028689	CAME MALE LAIT 1/2M1/2	MALE 1/2	MALE 1/2	0
028690	CAME MALE LAIT 3/4M3/4	MALE 3/4	MALE 3/4	0
028691	CAME MALE LAIT 1M1"	MALE 1"	MALE 1"	0
028692	CAME MALE LAIT 1"1/4M1"1/4	MALE 1"1/4	MALE 1"1/4	0
028693	CAME MALE LAIT 1"1/2M1"1/2	MALE 1"1/2	MALE 1"1/2	0
028694	CAME MALE LAIT 2M2"	MALE 2"	MALE 2"	0
028695	CAME MALE LAIT 2"1/2M2"1/2	MALE 2"1/2	MALE 2"1/2	0
028696	CAME MALE LAIT 3M3"	MALE 3"	MALE 3"	0
028697	CAME MALE LAIT 4M4"	MALE 4"	MALE 4"	0
028698	CAME MALE LAIT 5M5"	MALE 5"	MALE 5"	0
028699	CAME MALE LAIT 6M6"	MALE 6"	MALE 6"	0

Bouchon coupleur male



Bouchon coupleur male

Matière : laiton

Code	Référence	D1	D2	Poids
028711	BOUCH CAME LAIT MALE 1/2	MALE 1/2		0.06
028712	BOUCH CAME LAIT MALE 3/4	MALE 3/4		0.061
028713	BOUCH CAME LAIT MALE 1"	MALE 1"		0.118
028714	BOUCH CAME LAIT MALE 1"1/4	MALE 1"1/4		0.166
028715	BOUCH CAME LAIT MALE 1"1/2	MALE 1"1/2		0.224
028716	BOUCH CAME LAIT MALE 2"	MALE 2"		0.358
028717	BOUCH CAME LAIT MALE 2"1/2	MALE 2"1/2		0.479
028718	BOUCH CAME LAIT MALE 3"	MALE 3"		0.664
028719	BOUCH CAME LAIT MALE 4"	MALE 4"		1.07
028720	BOUCH CAME LAIT MALE 5"	MALE 5"		0
028721	BOUCH CAME LAIT MALE 6"	MALE 6"		0

Coupleur femelle douille annelée laiton



Coupleur femelle douille annelée laiton

Matière : laiton

Code	Référence	D1	D2	Poids
028666	CAME FEM LAIT 1/2D13	FEM 1/2	13mm	0.15
028667	CAME FEM LAIT 3/4D19	FEM 3/4	19mm	0.239
028668	CAME FEM LAIT 1D25	FEM 1"	25mm	0.275
028669	CAME FEM LAIT 1"1/4D32	FEM 1"1/4	32mm	0.43
028670	CAME FEM LAIT 1"1/2D40	FEM 1"1/2	40mm	0.483
028671	CAME FEM LAIT 2D50	FEM 2"	50mm	0.64
028672	CAME FEM LAIT 2"1/2D63	FEM 2"1/2	63mm	1.018
028673	CAME FEM LAIT 3D75	FEM 3"	75mm	0.976
028674	CAME FEM LAIT 4D100	FEM 4"	100mm	1.902
028675	CAME FEM LAIT 5D125	FEM 5"	125mm	0
028676	CAME FEM LAIT 6D150	FEM 6"	150mm	0

Coupleur taraudé femelle laiton



Coupleur taraudé femelle laiton

Matière : laiton

Code	Référence	D1	D2	Poids
028639	CAME FEM LAIT 1/2F1/2	FEM 1/2	FEM 1/2	0.147
028640	CAME FEM LAIT 3/4F3/4	FEM 3/4	FEM 3/4	0.226
022981	CAME FEM LAIT 1F1"	FEM 1"	FEM 1"	0.25
028641	CAME FEM LAIT 1"1/4F1"1/4	FEM 1"1/4	FEM 1"1/4	0.425
028642	CAME FEM LAIT 1"1/2F1"1/2	FEM 1"1/2	FEM 1"1/2	0.502
028643	CAME FEM LAIT 2F2"	FEM 2"	FEM 2"	0.647
006248	CAME FEM LAIT 2"1/2F2"1/2	FEM 2"1/2	FEM 2"1/2	0.84
019979	CAME FEM LAIT 3F3"	FEM 3"	FEM 3"	0.976
028644	CAME FEM LAIT 4F4"	FEM 4"	FEM 4"	1.504
028645	CAME FEM LAIT 5F5"	FEM 5"	FEM 5"	0
028646	CAME FEM LAIT 6F6"	FEM 6"	FEM 6"	0

Coupleur fileté male laiton



Coupleur fileté male laiton

Matière : laiton

Code	Référence	D1	D2	Poids
028677	CAME FEM LAIT 1/2M1/2	FEM 1/2	MALE 1/2	0.13
028678	CAME FEM LAIT 3/4M3/4	FEM 3/4	MALE 3/4	0.198
028679	CAME FEM LAIT 1M1"	FEM 1"	MALE 1"	0.27
028680	CAME FEM LAIT 1"1/4M1"1/4	FEM 1"1/4	MALE 1"1/4	0.399
028681	CAME FEM LAIT 1"1/2M1"1/2	FEM 1"1/2	MALE 1"1/2	0.413
028682	CAME FEM LAIT 2M2"	FEM 2"	MALE 2"	0.582
028683	CAME FEM LAIT 2"1/2M2"1/2	FEM 2"1/2	MALE 2"1/2	0
028684	CAME FEM LAIT 3M3"	FEM 3"	MALE 3"	0.893
028685	CAME FEM LAIT 4M4"	FEM 4"	MALE 4"	1.338
028686	CAME FEM LAIT 5M5"	FEM 5"	MALE 5"	0
028687	CAME FEM LAIT 6M6"	FEM 6"	MALE 6"	0

Bouchon coupleur femelle



Bouchon coupleur femelle

Matière : laiton

Code	Référence	D1	D2	Poids
028700	BOUCH CAME LAIT FEM 1/2	FEM 1/2		0.17
028701	BOUCH CAME LAIT FEM 3/4	FEM 3/4		0.153
028702	BOUCH CAME LAIT FEM 1"	FEM 1"		0.251
028703	BOUCH CAME LAIT FEM 1"1/4	FEM 1"1/4		0.394
028704	BOUCH CAME LAIT FEM 1"1/2	FEM 1"1/2		0.471
028705	BOUCH CAME LAIT FEM 2"	FEM 2"		0.574
028706	BOUCH CAME LAIT FEM 2"1/2	FEM 2"1/2		0
028707	BOUCH CAME LAIT FEM 3"	FEM 3"		0.852
028708	BOUCH CAME LAIT FEM 4"	FEM 4"		1.289
028709	BOUCH CAME LAIT FEM 5"	FEM 5"		0
028710	BOUCH CAME LAIT FEM 6"	FEM 6"		0

11- RACCORD CAME INOX



Adapteur male douille annelée inox



Adapteur male annelée inox

Matière : inox

Code	Référence	D1	D2	Poids
028381	CAME MALE INOX 1/2D13	MALE 1/2	13mm	0
006253	CAME MALE INOX 3/4D19	MALE 3/4	19mm	0.112
006252	CAME MALE INOX 1D25	MALE 1"	25mm	0
028374	CAME MALE INOX 1"1/4D32	MALE 1"1/4	32mm	0
044828	CAME MALE INOX 1"1/2D38	MALE 1"1/2	38mm	0
028375	CAME MALE INOX 2D50	MALE 2"	50mm	0
028383	CAME MALE INOX 2"1/2D63	MALE 2"1/2	63mm	0
028384	CAME MALE INOX 3D75	MALE 3"	75mm	0
028385	CAME MALE INOX 4D100	MALE 4"	100mm	0
028387	CAME MALE INOX 5D125	MALE 5"	125mm	0
028386	CAME MALE INOX 6D150	MALE 6"	150mm	0

Adapteur taraudé femelle inox



Adapteur taraudé femelle inox

Matière : inox

Code	Référence	D1	D2	Poids
028426	CAME MALE INOX 1/2F1/2	MALE 1/2	FEM 1/2	0.06
006254	CAME MALE INOX 3/4F3/4	MALE 3/4	FEM 3/4	0.093
006251	CAME MALE INOX 1F1"	MALE 1"	FEM 1"	0
028427	CAME MALE INOX 1"1/4F1"1/4	MALE 1"1/4	FEM 1"1/4	0
028428	CAME MALE INOX 1"1/2F1"1/2	MALE 1"1/2	FEM 1"1/2	0.238
028429	CAME MALE INOX 2F2"	MALE 2"	FEM 2"	0
021343	CAME MALE INOX 2"1/2F2"1/2	MALE 2"1/2	FEM 2"1/2	0
028430	CAME MALE INOX 3F3"	MALE 3"	FEM 3"	0
028431	CAME MALE INOX 4F4"	MALE 4"	FEM 4"	0
028432	CAME MALE INOX 5F5"	MALE 5"	FEM 5"	0
028433	CAME MALE INOX 6F6"	MALE 6"	FEM 6"	0

Adapteur fileté mâle inox



Adapteur fileté mâle inox

Matière : inox

Code	Référence	D1	D2	Poids
028402	CAME MALE INOX 1/2M1/2	MALE 1/2	MALE 1/2	0
006255	CAME MALE INOX 3/4M3/4	MALE 3/4	MALE 3/4	0
028403	CAME MALE INOX 1M1"	MALE 1"	MALE 1"	0
028405	CAME MALE INOX 1"1/4M1"1/4	MALE 1"1/4	MALE 1"1/4	0
028407	CAME MALE INOX 1"1/2M1"1/2	MALE 1"1/2	MALE 1"1/2	0
028408	CAME MALE INOX 2M2"	MALE 2"	MALE 2"	0
021344	CAME MALE INOX 2"1/2M2"1/2	MALE 2"1/2	MALE 2"1/2	0
028409	CAME MALE INOX 3M3"	MALE 3"	MALE 3"	0
028410	CAME MALE INOX 4M4"	MALE 4"	MALE 4"	0
028411	CAME MALE INOX 5M5"	MALE 5"	MALE 5"	0
028412	CAME MALE INOX 6M6"	MALE 6"	MALE 6"	0

Bouchon coupleur male



Bouchon coupleur male

Matière : inox

Code	Référence	D1	D2	Poids
028445	BOUCH CAME INOX MALE 1/2	MALE 1/2		0.039
028446	BOUCH CAME INOX MALE 3/4	MALE 3/4		0
028447	BOUCH CAME INOX MALE 1"	MALE 1"		0
028448	BOUCH CAME INOX MALE 1"1/4	MALE 1"1/4		0
028449	BOUCH CAME INOX MALE 1"1/2	MALE 1"1/2		0
028450	BOUCH CAME INOX MALE 2"	MALE 2"		0
021345	BOUCH CAME INOX MALE 2"1/2	MALE 2"1/2		0
028451	BOUCH CAME INOX MALE 3"	MALE 3"		0
028452	BOUCH CAME INOX MALE 4"	MALE 4"		0
028453	BOUCH CAME INOX MALE 5"	MALE 5"		0
028454	BOUCH CAME INOX MALE 6"	MALE 6"		0

Coupleur femelle douille annelée inox



Coupleur femelle douille annelée inox

Matière : inox

Code	Référence	D1	D2	Poids
006239	CAME FEM INOX 1/2D13	FEM 1/2	13mm	0
006242	CAME FEM INOX 3/4D19	FEM 3/4	19mm	0.235
006240	CAME FEM INOX 1D25	FEM 1"	25mm	0
044186	CAME FEM INOX 1"1/4D32	FEM 1"1/4	32mm	0
006246	CAME FEM INOX 1"1/2D38	FEM 1"1/2	38mm	0
044827	CAME FEM INOX 2D50	FEM 2"	50mm	0.63
006247	CAME FEM INOX 2"1/2D65	FEM 2"1/2	65mm	0
028376	CAME FEM INOX 3D75	FEM 3"	75mm	0
028378	CAME FEM INOX 4D100	FEM 4"	100mm	0
028379	CAME FEM INOX 5D125	FEM 5"	125mm	0
028380	CAME FEM INOX 6D150	FEM 6"	150mm	0

Coupleur taraudé femelle inox



Coupleur taraudé femelle inox

Matière : inox

Code	Référence	D1	D2	Poids
028417	CAME FEM INOX 1/2F1/2	FEM 1/2	FEM 1/2	0.229
006243	CAME FEM INOX 3/4F3/4	FEM 3/4	FEM 3/4	0.173
006241	CAME FEM INOX 1F1"	FEM 1"	FEM 1"	0.23
028418	CAME FEM INOX 1"1/4F1"1/4	FEM 1"1/4	FEM 1"1/4	0
028419	CAME FEM INOX 1"1/2F1"1/2	FEM 1"1/2	FEM 1"1/2	0.4
028420	CAME FEM INOX 2F2"	FEM 2"	FEM 2"	0
028421	CAME FEM INOX 2"1/2F2"1/2	FEM 2"1/2	FEM 2"1/2	0
028422	CAME FEM INOX 3F3"	FEM 3"	FEM 3"	0
028423	CAME FEM INOX 4F4"	FEM 4"	FEM 4"	0
028424	CAME FEM INOX 5F5"	FEM 5"	FEM 5"	0
028425	CAME FEM INOX 6F6"	FEM 6"	FEM 6"	0

Coupleur fileté mâle inox



Coupleur fileté mâle inox

Matière : inox

Code	Référence	D1	D2	Poids
028388	CAME FEM INOX 1/2M1/2	FEM 1/2	MALE 1/2	0
006244	CAME FEM INOX 3/4M3/4	FEM 3/4	MALE 3/4	0
028389	CAME FEM INOX 1M1"	FEM 1"	MALE 1"	0
028390	CAME FEM INOX 1"1/4M1"1/4	FEM 1"1/4	MALE 1"1/4	0
028391	CAME FEM INOX 1"1/2M1"1/2	FEM 1"1/2	MALE 1"1/2	0
028392	CAME FEM INOX 2M2"	FEM 2"	MALE 2"	0
021342	CAME FEM INOX 2"1/2M2"1/2	FEM 2"1/2	MALE 2"1/2	0
028393	CAME FEM INOX 3M3"	FEM 3"	MALE 3"	0
028394	CAME FEM INOX 4M4"	FEM 4"	MALE 4"	0
028395	CAME FEM INOX 5M5"	FEM 5"	MALE 5"	0
028396	CAME FEM INOX 6M6"	FEM 6"	MALE 6"	0

Bouchon coupleur femelle



Bouchon coupleur femelle

Matière : inox

Code	Référence	D1	D2	Poids
028434	BOUCH CAME INOX FEM 1/2	FEM 1/2		0
028435	BOUCH CAME INOX FEM 3/4	FEM 3/4		0.21
028436	BOUCH CAME INOX FEM 1"	FEM 1"		0
028437	BOUCH CAME INOX FEM 1"1/4	FEM 1"1/4		0
028438	BOUCH CAME INOX FEM 1"1/2	FEM 1"1/2		0
028440	BOUCH CAME INOX FEM 2"	FEM 2"		0
021346	BOUCH CAME INOX FEM 2"1/2	FEM 2"1/2		0
028441	BOUCH CAME INOX FEM 3"	FEM 3"		0
028442	BOUCH CAME INOX FEM 4"	FEM 4"		0
028443	BOUCH CAME INOX FEM 5"	FEM 5"		0
028444	BOUCH CAME INOX FEM 6"	FEM 6"		0

12- RACCORD CAME POLYPROPYLENE



Adapteur male douille annelée polypro



Adapteur male annelée polypro

Matière : polypro

Code	Référence	D1	D2	Poids
044832	CAME MALE PP 1/2D13	MALE 1/2	13mm	0
028734	CAME MALE PP 3/4D19	MALE 3/4	19mm	0
028736	CAME MALE PP 1"1/4D32	MALE 1"1/4	32mm	0
028737	CAME MALE PP 1"1/2D40	MALE 1"1/2	40mm	0
022319	CAME MALE PP 2D50	MALE 2"	50mm	0
028738	CAME MALE PP 3D75	MALE 3"	75mm	0
028739	CAME MALE PP 4D100	MALE 4"	100mm	0

Adapteur taraudé femelle polypro



Adapteur taraudé femelle polypro

Matière : polypro

Code	Référence	D1	D2	Poids
044849	CAME MALE PP 1/2F1/2	MALE 1/2	FEM 1/2	0
028759	CAME MALE PP 3/4F3/4	MALE 3/4	FEM 3/4	0
028760	CAME MALE PP 1F1"	MALE 1"	FEM 1"	0
028761	CAME MALE PP 1"1/4F1"1/4	MALE 1"1/4	FEM 1"1/4	0
028762	CAME MALE PP 1"1/2F1"1/2	MALE 1"1/2	FEM 1"1/2	0
028763	CAME MALE PP 2F2"	MALE 2"	FEM 2"	0
028764	CAME MALE PP 3F3"	MALE 3"	FEM 3"	0
028765	CAME MALE PP 4F4"	MALE 4"	FEM 4"	0

Adapteur fileté male polypro



Adapteur fileté male polypro

Matière : polypro

Code	Référence	D1	D2	Poids
044836	CAME MALE PP 1/2M1/2	MALE 1/2	MALE 1/2	0
028746	CAME MALE PP 3/4M3/4	MALE 3/4	MALE 3/4	0
028747	CAME MALE PP 1M1"	MALE 1"	MALE 1"	0
028748	CAME MALE PP 1"1/4M1"1/4	MALE 1"1/4	MALE 1"1/4	0
028749	CAME MALE PP 1"1/2M1"1/2	MALE 1"1/2	MALE 1"1/2	0
022979	CAME MALE PP 2M2"	MALE 2"	MALE 2"	0
028750	CAME MALE PP 3M3"	MALE 3"	MALE 3"	0
028751	CAME MALE PP 4M4"	MALE 4"	MALE 4"	0

Bouchon adapteur male polypro



Bouchon adapteur male polypro

Matière : polypro

Code	Référence	D1	D2	Poids
044872	BOUCH CAME PP MALE 1/2	MALE 1/2		0
028773	BOUCH CAME PP MALE 3/4	MALE 3/4		0
028774	BOUCH CAME PP MALE 1"	MALE 1"		0
028775	BOUCH CAME PP MALE 1"1/4	MALE 1"1/4		0
028776	BOUCH CAME PP MALE 1"1/2	MALE 1"1/2		0
028777	BOUCH CAME PP MALE 2"	MALE 2"		0
028779	BOUCH CAME PP MALE 3"	MALE 3"		0
028780	BOUCH CAME PP MALE 4"	MALE 4"		0

Coupleur femelle douille annelée polypro



Coupleur femelle douille annelée polypro

Matière : polypro

Code	Référence	D1	D2	Poids
044829	CAME FEM PP 1/2D13	FEM 1/2	13mm	0
028728	CAME FEMM PP 3/4D19	FEM 3/4	19mm	0
028729	CAME FEM PP 1D25	FEM 1"	25mm	0
028730	CAME FEM PP 1"1/4D32	FEM 1"1/4	32mm	0
028731	CAME FEM PP 1"1/2D40	FEM 1"1/2	40mm	0
028732	CAME FEM PP 3D75	FEM 3"	75mm	0
028733	CAME FEM PP 4D100	FEM 4"	100mm	0

Coupleur taraudé femelle polypro



Coupleur taraudé femelle polypro

Matière : polypro

Code	Référence	D1	D2	Poids
044848	CAME FEM PP 1/2F1/2	FEM 1/2	FEM 1/2	0
028752	CAME FEM PP 3/4F3/4	FEM 3/4	FEM 3/4	0
028753	CAME FEM PP 1F1"	FEM 1"	FEM 1"	0
028754	CAME FEM PP 1"1/4F1"1/4	FEM 1"1/4	FEM 1"1/4	0
028755	CAME FEM PP 1"1/2F1"1/2	FEM 1"1/2	FEM 1"1/2	0
028756	CAME FEM PP 2F2"	FEM 2"	FEM 2"	0
028757	CAME FEM PP 3F3"	FEM 3"	FEM 3"	0
028758	CAME FEM PP 4F4"	FEM 4"	FEM 4"	0

Coupleur fileté male polypro



Coupleur fileté male polypro

Matière : polypro

Code	Référence	D1	D2	Poids
044830	CAME FEM PP 1/2M1/2	FEM 1/2	MALE 1/2	0
028740	CAME FEM PP 3/4M3/4	FEM 3/4"	MALE 3/4	0
028741	CAME FEM PP 1M1"	FEM 1"	MALE 1"	0
028742	CAME FEM PP 1"1/4M1"1/4	FEM 1"1/4	MALE 1"1/4	0
028743	CAME FEM PP 1"1/2M1"1/2	FEM 1"1/2	MALE 1"1/2	0
022980	CAME FEM PP 2M2"	FEM 2"	MALE 2"	0
028744	CAME FEM PP 3M3"	FEM 3"	MALE 3"	0
028745	CAME FEM PP 4M4"	FEM 4"	MALE 4"	0

Bouchon adaptateur femelle polypro



Bouchon adaptateur femelle polypro

Matière : polypro

Code	Référence	D1	D2	Poids
044869	BOUCH CAME PP FEM 1/2	FEM 1/2		0
028766	BOUCH CAME PP FEM 3/4	FEM 3/4		0
028767	BOUCH CAME PP FEM 1"	FEM 1"		0
028768	BOUCH CAME PP FEM 1"1/4	FEM 1"1/4		0
028769	BOUCH CAME PP FEM 1"1/2	FEM 1"1/2		0
028770	BOUCH CAME PP FEM 2"	FEM 2"		0
028771	BOUCH CAME PP FEM 3"	FEM 3"		0
028772	BOUCH CAME PP FEM 4"	FEM 4"		0

12- JOINT POUR RACCORD A CAME



Joint pour racc à came NBR



Joint à came NBR

Matière : Nitrile

Code	Référence	D1	/	Poids
028543	JOINT CAME NBR 1/2	1/2		0
028546	JOINT CAME NBR 3/4	3/4		0.003
028547	JOINT CAME NBR 1"	1"		0
028548	JOINT CAME NBR 1"1/4	1"1/4		0
008650	JOINT CAME NBR 1"1/2	1"1/2		0
028549	JOINT CAME NBR 2"	2"		0
008651	JOINT CAME NBR 2"1/2	2"1/2		0
008652	JOINT CAME NBR 3"	3"		0
028550	JOINT CAME NBR 4"	4"		0
028551	JOINT CAME NBR 5"	5"		0
028552	JOINT CAME NBR 6"	6"		0

Joint pour racc à came EPDM



Joint à came EPDM

Matière : EPDM

Code	Référence	D1	/	Poids
028553	JOINT CAME EPDM 1/2	1/2		0
028554	JOINT CAME EPDM 3/4	3/4		0
028555	JOINT CAME EPDM 1"	1"		0
028556	JOINT CAME EPDM 1"1/4	1"1/4		0
028557	JOINT CAME EPDM 1"1/2	1"1/2		0
028558	JOINT CAME EPDM 2"	2"		0
028559	JOINT CAME EPDM 2"1/2	2"1/2		0
028560	JOINT CAME EPDM 3"	3"		0
028561	JOINT CAME EPDM 4"	4"		0

Joint pour racc à came VITON

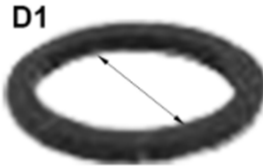

Joint à came viton

Matière : viton

Code	Référence	D1	/	Poids
028562	JOINT CAME VITON 1/2	1/2		0
028563	JOINT CAME VITON 3/4	3/4		0
008653	JOINT CAME VITON 1"	1"		0
028565	JOINT CAME VITON 1"1/4	1"1/4		0
028566	JOINT CAME VITON 1"1/2	1"1/2		0
028567	JOINT CAME VITON 2"	2"		0
028568	JOINT CAME VITON 2"1/2	2"1/2		0
028569	JOINT CAME VITON 3"	3"		0
028570	JOINT CAME VITON 4"	4"		0

13- RACCORD TANKWAGEN



Raccord tankwagen male taraudé femelle



Raccord tankwagen male taraudé femelle (camion-citerne)

Matière : Laiton ou inox
Pression nominale : 16 bars

Code	Référence	Dn (mm)	D1	Poids
INOX				
044779	JONCT TW/VK INOX 50F2"	50	2"	0
044780	JONCT TW/VK INOX 80F3"	80	3"	0
044781	JONCT TW/VK INOX 100F4"	100	4"	0
LAITON				
044773	JONCT TW/VK LAIT 50F2"	50	2"	0
044774	JONCT TW/VK LAIT 80F3"	80	3"	0
044775	JONCT TW/VK LAIT 100F4"	100	4"	0

Raccord tankwagen femelle taraudé femelle



Raccord tankwagen femelle taraudé femelle (camion-citerne)

Matière : Laiton ou inox
Pression nominale : 16 bars

Code	Référence	Dn (mm)	D1	Poids
INOX				
044776	JONCT TW/MK INOX 50F2"	50	2"	0
044777	JONCT TW/MK INOX 80F3"	80	3"	0
044778	JONCT TW/MK INOX 100F4"	100	4"	0
LAITON				
044770	JONCT TW/MK LAIT 50F2"	50	2"	0
044771	JONCT TW/MK LAIT 80F3"	80	3"	0
044772	JONCT TW/MK LAIT 100F4"	100	4"	0

Bouchon tankwagen male



Bouchon tankwagen male (camion-citerne)

Matière : Laiton ou inox
Pression nominale : 16 bars

Code	Référence	Dn (mm)	D1	Poids
INOX				
044788	BOUCH TW/MB INOX 50	50		0
044789	BOUCH TW/MB INOX 80	80		0
044790	BOUCH TW/MB INOX 100	100		0
LAITON				
121803	BOUCH TW/MB LAIT 100	100		0
044782	BOUCH TW/MB LAIT 50	50		0
044783	BOUCH TW/MB LAIT 80	80		0
NITRILE				
044794	JOINT TW NITRILE 50	50		0

Bouchon tankwagen femelle



Bouchon tankwagen femelle (camion-citerne)

Matière : Laiton ou inox
Pression nominale : 16 bars

Code	Référence	Dn (mm)	D1	Poids
INOX				
044791	BOUCH TW/VB INOX 50	50		0
044792	BOUCH TW/VB INOX 80	80		0
044793	BOUCH TW/VB INOX 100	100		0
LAITON				
044784	BOUCH TW/VB LAIT 50	50		0
044785	BOUCH TW/VB LAIT 80	80		0
044786	BOUCH TW/VB LAIT 100	100		0

Joint plat pour raccord Tankwagen

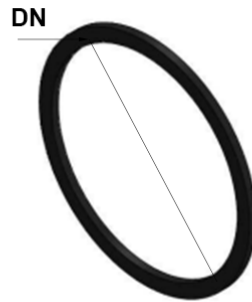

Joint plat pour raccord Tankwagen

Code	Référence	Dn (mm)	D1	Poids
NITRILE				
044795	JOINTS TW NITRILE 80	POUR 80		0
044798	JOINT TW NITRILE 80	POUR 80		0
122124	JOINT TW NITRILE 100	POUR 100		0
PTFE				
122126	JOINT TW PTFE 50	POUR 50		0
122127	JOINT TW PTFE 80	POUR 80		0
122129	JOINT TW PTFE 100	POUR 100		0
VITON				
044796	JOINT TW VITON 50	POUR 50		0
044797	JOINT TW VITON 80	POUR 80		0
122125	JOINT TW VITON 100	POUR 100		0

14- BRIDES ACIER



Bride taraudée PN10/16 acier

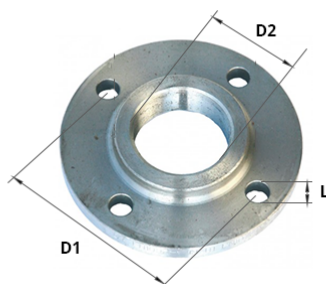

Bride taraudée en acier PN10/16 acier

Normes : EN 1092-1 type 13 - Taraudage norme ISO7-1

Matière : Acier P245GH

Pression maximale de service : 16 Bars

Code	Référence	DN	D1	Nb trous	L	D2	Poids
041229	BRIDE/PN10 DN15XFG1/2	15mm	65mm	4x12	14mm	FEM 1/2	0
041230	BRIDE/PN10 DN20XFG3/4	20mm	75mm	4x12	14mm	FEM 3/4	0
041231	BRIDE/PN10 DN25XFG1"	25mm	85mm	4X16	14mm	FEM 1"	0
041232	BRIDE/PN10 DN32XFG1"1/4	32mm	100mm	4x16	18mm	FEM 1"1/4	0
041233	BRIDE/PN10 DN40XFG1"1/2	40mm	110mm	4x16	18mm	FEM 1"1/2	0
041234	BRIDE/PN10 DN50XFG2"	50mm	125mm	4x16	18mm	FEM 2"	0
041235	BRIDE/PN10 DN65XFG2"1/2	65mm	145mm	8x16	18mm	FEM 2"1/2	0
041236	BRIDE/PN10 DN80XFG3"	80mm	160mm	8x16	18mm	FEM 3"	0
041237	BRIDE/PN10 DN100XFG4"	100mm	180mm	8x16	18mm	FEM 4"	0

Bride plate à souder PN10/16 acier

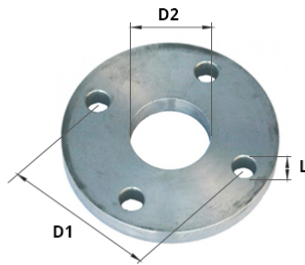

Bride plate à souder PN10/16 acier

Normes : EN 1092-1 type 01 (Sauf 810-133 et 810-159 : DIN 2576)

Matière : Acier P245GH

Pression maximale de service : 16 Bars

Code	Référence	DN	D1	Nb trous	L	D2	Poids
041243	BRIDE/PN10 DN15XSOU21	15mm	65mm	4x12	14mm	21.3mm	0
041244	BRIDE/PN10 DN20XSOU26	20mm	75mm	4x12	14mm	26.9mm	0
041245	BRIDE/PN10 DN25XSOU33	25mm	85mm	4x12	14mm	33.7mm	0
041246	BRIDE/PN10 DN32XSOU42	32mm	100mm	4x16	18mm	42.4mm	0
041247	BRIDE/PN10 DN40XSOU48	40mm	110mm	4x16	18mm	48.3mm	0
041248	BRIDE/PN10 DN50XSOU60	50mm	125mm	4x16	18mm	60.3mm	0
041250	BRIDE/PN10 DN65XSOU76	65mm	145mm	8x16	18mm	76.1mm	0
041251	BRIDE/PN10 DN80XSOU88	80mm	160mm	8x16	18mm	98.9mm	0
041252	BRIDE/PN10 DN100XSOU114	100mm	180mm	8x16	18mm	114.3mm	0
041254	BRIDE/PN10 DN125XSOU139	125mm	210mm	8x16	18mm	139.7mm	0
041256	BRIDE/PN10 DN150XSOU159	150mm	240mm	8x20	22mm	159mm	0
041257	BRIDE/PN10 DN150XSOU168	150mm	240mm	8x20	22mm	168.3mm	0
041258	BRIDE/PN10 DN200XSOU219	200mm	295mm	8x20	22mm	219.1mm	0
041259	BRIDE/PN16 DN200XSOU219	200mm	295mm	12x20	22mm	219.1mm	0

Bride à colerette à souder PN10/16 acier

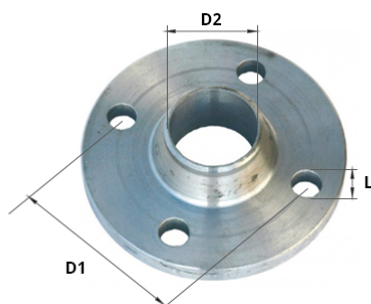

Bride à colerette à souder PN10/16 acier

Normes : EN 1092-1 type 11 (Sauf 810C-133 et 810C-139 : DIN 2633)

Matière : Acier P245GH

Pression maximale de service : 16 Bars

Code	Référence	DN	D1	Nb trous	L	D2	Poids
041279	BRIDE/PN10 DN15XCOL21	15mm	65mm	4x12	14mm	21.3mm	0
041283	BRIDE/PN10 DN20XCOL26	20mm	75mm	4x12	14mm	26.9mm	0
041286	BRIDE/PN10 DN25XCOL33	25mm	85mm	4x12	14mm	33.7mm	0
041278	BRIDE/PN10 DN32XCOL42	32mm	100mm	4x16	18mm	42.4mm	0
041287	BRIDE/PN10 DN40XCOL48	40mm	110mm	4x16	18mm	48.3mm	0
041289	BRIDE/PN10 DN50XCOL60	50mm	125mm	4x16	18mm	60.3mm	0
041290	BRIDE/PN10 DN65XCOL76	65mm	145mm	8x16	18mm	76.1mm	0
041291	BRIDE/PN10 DN80XCOL88	80mm	160mm	8x16	18mm	98.9mm	0
041292	BRIDE/PN10 DN100XCOL114	100mm	180mm	8x16	18mm	114.3mm	0
041293	BRIDE/PN10 DN125XCOL133	125mm	210mm	8x16	18mm	133mm	0
041296	BRIDE/PN10 DN125XCOL139	125mm	210mm	8x16	18mm	139.7mm	0
041297	BRIDE/PN10 DN150XCOL159	150mm	240mm	8x20	22mm	159mm	0
041298	BRIDE/PN10 DN150XCOL168	150mm	240mm	8x20	22mm	168.3mm	0
041299	BRIDE/PN10 DN200XCOL219	200mm	295mm	8x20	22mm	219.1mm	0
041301	BRIDE/PN16 DN200XCOL219	200mm	295mm	12x20	22mm	219.1mm	0

Bride pleine PN10/16 acier

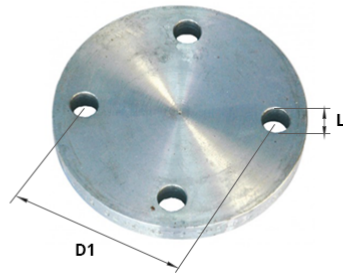

Bride pleine PN10/16 acier

Normes : EN 1092-1 type 05

Matière : Acier P245GH

Pression maximale de service : 16 Bars

Code	Référence	DN	D1	Nb trous	L	D2	Poids
041302	BRIDE/PN10 DN15XPLEINE	15mm	65mm	4x12	14mm		0
041303	BRIDE/PN10 DN20XPLEINE	20mm	75mm	4x12	14mm		0
041305	BRIDE/PN10 DN25XPLEINE	25mm	85mm	4x12	14mm		0
041306	BRIDE/PN10 DN32XPLEINE	32mm	100mm	4x16	18mm		0
041307	BRIDE/PN10 DN40XPLEINE	40mm	110mm	4x16	18mm		0
041308	BRIDE/PN10 DN50XPLEINE	50mm	125mm	4x16	18mm		0
041309	BRIDE/PN10 DN65XPLEINE	65mm	145mm	8x16	18mm		0
041310	BRIDE/PN10 DN80XPLEINE	80mm	160mm	8x16	18mm		0
041311	BRIDE/PN10 DN100XPLEINE	100mm	180mm	8x16	18mm		0
041312	BRIDE/PN10 DN125XPLEINE	125mm	210mm	8x16	18mm		0
041313	BRIDE/PN10 DN150XPLEINE	150mm	240mm	8x20	22mm		0
041314	BRIDE/PN10 DN200XPLEINE	200mm	295mm	8x20	22mm		0
041315	BRIDE/PN16 DN200XPLEINE	200mm	295mm	12x20	22mm		0

Embout à bride tournante PN10/PN16 acier

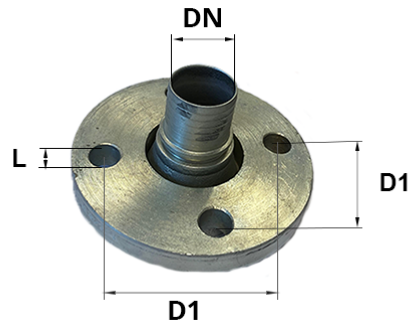

Bride tournante à douille lisse ou à douille crantée PN10/PN16 acier

Normes : EN 1092-1 type 01 (Sauf 810-133 et 810-159 : DIN 2576)

Matière : Acier P245GH

Pression maximale de service : 16 Bars

Code	Référence	DN	D1	Nb trous	L	D2	Poids
DOUILLE ANNELEE							
075347	EMBOUT BRIDE/PN10 TOUR DN32 CRANTE	32mm	100mm	4x16	18mm		0
034960	EMBOUT BRIDE/PN10 TOUR DN40 CRANTE	40mm	110mm	4x16	18mm		0
034961	EMBOUT BRIDE/PN10 TOUR DN50 CRANTE	50mm	125mm	4x16	18mm		0
034962	EMBOUT BRIDE/PN10 TOUR DN65 CRANTE	65mm	145mm	8x16	18mm		0
034963	EMBOUT BRIDE/PN10 TOUR DN80 CRANTE	80mm	160mm	8x16	18mm		0
034964	EMBOUT BRIDE/PN10 TOUR DN100 CRANTE	100mm	180mm	8x16	18mm		0
061035	EMBOUT BRIDE/PN10 TOUR DN125 CRANTE	125mm	210mm	8x16	18mm		0
053117	EMBOUT BRIDE/PN10 TOUR DN150 CRANTE	150mm	240mm	8x20	22mm		0
DOUILLE LISSE							
069660	EMBOUT BRIDE/PN10 TOUR DN25	25mm	85mm	4x12	14mm		0
075348	EMBOUT BRIDE/PN10 TOUR DN32	32mm	100mm	4x16	18mm		0
034959	EMBOUT BRIDE/PN10 TOUR DN40	40mm	110mm	4x16	18mm		0
034957	EMBOUT BRIDE/PN10 TOUR DN50	50mm	125mm	4x16	18mm		0
034953	EMBOUT BRIDE/PN10 TOUR DN65	65mm	145mm	8x16	18mm		0

Joint fibre pour bride PN10/16

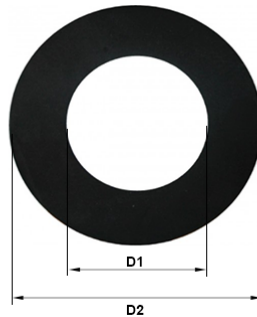

Joint fibre pour bride PN10/16

Utilisations : Eau, application générale
Composition : Fibre organique NBR
Limites de températures : -40°C à +120°C
PMS : 40 Bars
Épaisseur : 2 mm
Norme : NF EN 1514-1

Code	Référence	DN	D1	Nb trous	L	D2	Poids
060536	JOINT BRIDE/PN10 DN15 FIBRE	15mm	22mm			51mm	0
060537	JOINT BRIDE/PN10 DN20 FIBRE	20mm	27mm			61mm	0
060538	JOINT BRIDE/PN10 DN25 FIBRE	25mm	34mm			71mm	0
041327	JOINT BRIDE/PN10 DN32 FIBRE	32mm	43mm			82mm	0
041328	JOINT BRIDE/PN10 DN40 FIBRE	40mm	49mm			92mm	0
041329	JOINT BRIDE/PN10 DN50 FIBRE	50mm	61mm			107mm	0
041330	JOINT BRIDE/PN10 DN65 FIBRE	65mm	77mm			127mm	0
042384	JOINT BRIDE/PN10 DN80 FIBRE	80mm	90mm			135mm	0
042385	JOINT BRIDE/PN10 DN100 FIBRE	100mm	115mm			162mm	0
042386	JOINT BRIDE/PN10 DN150 FIBRE	150mm	150mm			220mm	0
077910	JOINT BRIDE/PN10 DN200 FIBRE	200mm	223mm			273mm	0
090286	JOINT BRIDE/PN10 DN250 FIBRE	250mm	260mm			365mm	0
090285	JOINT BRIDE/PN10 DN300 FIBRE	300mm	324mm			384mm	0

Joint aramide pour bride PN10/16

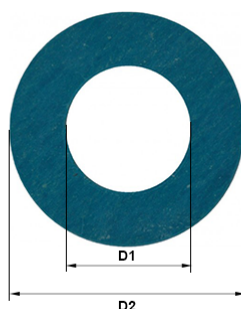

Joint Aramide pour bride PN10/16

Utilisations : Eau, huile, gaz, acides minéraux, carburant

Composition : Fibres aramides NBR

Limites de températures : -40°C à +250°C

PMS : 100 Bars

Épaisseur : 2 mm

Norme : NF EN 1514-1

Code	Référence	DN	D1	Nb trous	L	D2	Poids
056862	JOINT BRIDE/PN10 DN15 ARAM	15mm	22mm			51mm	0
056867	JOINT BRIDE/PN10 DN20 ARAM	20mm	27mm			61mm	0
056868	JOINT BRIDE/PN10 DN25 ARAM	25mm	34mm			71mm	0
056869	JOINT BRIDE/PN10 DN32 ARAM	32mm	43mm			82mm	0
056870	JOINT BRIDE/PN10 DN40 ARAM	70mm	49mm			92mm	0
056871	JOINT BRIDE/PN10 DN50 ARAM	50mm	61mm			107mm	0
056882	JOINT BRIDE/PN10 DN65 ARAM	65mm	77mm			127mm	0
056883	JOINT BRIDE/PN10 DN80 ARAM	80mm	89mm			142mm	0
056884	JOINT BRIDE/PN10 DN 100 ARAM	100mm	115mm			162mm	0
056885	JOINT BRIDE/PN10 DN 125 ARAM	125mm	141mm			192mm	0
056886	JOINT BRIDE/PN10 DN150 ARAM	150mm	150mm			220mm	0
056887	JOINT BRIDE/PN10 DN200 ARAM	200mm	220mm			284mm	0
056889	JOINT BRIDE/PN10 DN250 ARAM	250mm	273mm			340mm	0
056890	JOINT BRIDE/PN10 DN300 ARAM	300mm	324mm			378mm	0

Vis pour bride

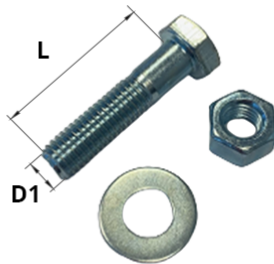

(Vis + rondelles + écrou)

Matière : Acier

Code	Référence	DN	D1	Nb trous	L	D2	Poids
122174	VIS BRIDE PN10/16 DN10-25 COMPLETE		12mm			50mm	0
056309	VIS BRIDE PN10/16 DN32/50 COMPLETE		16mm			60mm	0
122175	VIS BRIDE PN10/16 DN65-125 COMPLETE		16mm			70mm	0
078042	VIS BRIDE PN10/16 DN150-200 COMPLETE		20mm			80mm	0

15- RACCORD EN ACIER GALVANISE

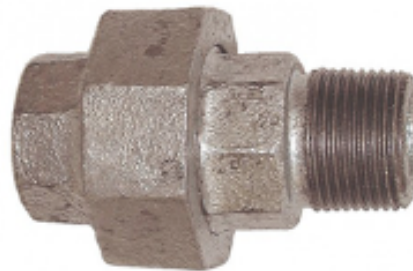

Bouchon male carré

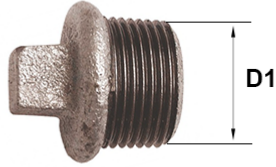

Bouchon male carré

Utilisations : Fluides courants compatibles.

Matière : Fonte galvanisée

Limites de températures et PMS :

De -20°C à +120°C : PMS = 25 Bars

De +120°C à +300°C : PMS = 20 Bars

Code	Référence	D1	D2	Poids
		MALE		
039903	290G 1/8	MALE 1/8		0.007
001415	290G 1/4	MALE 1/4		0.017
001418	290G 3/8	MALE 3/8		0.03
001414	290G 1/2	MALE 1/2		0.036
001417	290G 3/4	MALE 3/4		0.073
001411	290G 1"	MALE 1"		0.11
001413	290G 1"1/4	MALE 1"1/4		0.217
001412	290G 1"1/2	MALE 1"1/2		0.225
001416	290G 2"	MALE 2"		0.434
018057	290G 2"1/2	MALE 2"1/2		0.665
018056	290G 3"	MALE 3"		0.995
018058	290G 4"	MALE 4"		1.77

Bouchon femelle hexagonal

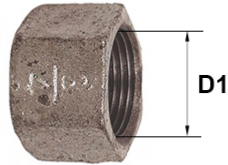

Bouchon femelle hexagonal

Utilisations : Fluides courants compatibles.

Matière : Fonte galvanisée

Limites de températures et PMS :

De -20°C à +120°C : PMS = 25 Bars

De +120°C à +300°C : PMS = 20 Bars

Code	Référence	D1	D2	Poids
FEMELLE.				
001507	300G 1/4	FEM 1/4		0.019
001510	300G 3/8	FEM 3/8		0.032
001506	300G 1/2	FEM 1/2		0.042
001509	300G 3/4	FEM 3/4		0.063
001503	300G 1"	FEM 1"		0.115
001505	300G 1"1/4	FEM 1"1/4		0.15
001504	300G 1"1/2	FEM 1"1/2		0.177
001508	300G 2"	FEM 2"		0.265
018059	300G 2"1/2	FEM 2"1/2		0.536
018061	300G 3"	FEM 3"		0.676
018063	300G 4"	FEM 4"		1.3

Mamelon male x male



Mamelon male x male

Utilisations : Fluides courants compatibles.

Matière : Fonte galvanisée

Limites de températures et PMS :

De -20°C à +120°C : PMS = 25 Bars

De +120°C à +300°C : PMS = 20 Bars

Code	Référence	D1	D2	Poids
EGAUX				
001390	280G 1/8	MALE 1/8	MALE 1/8	0
001389	280G 1/4	MALE 1/4	MALE 1/4	0.02
001394	280G 3/8	MALE 3/8	MALE 3/8	0.042
001388	280G 1/2	MALE 1/2	MALE 1/2	0.063
001393	280G 3/4	MALE 3/4	MALE 3/4	0.095
001385	280G 1"	MALE 1"	MALE 1"	0.154
001387	280G 1"1/4	MALE 1"1/4	MALE 1"1/4	0.208
001386	280G 1"1/2	MALE 1"1/2	MALE 1"1/2	0.235
001391	280G 2"	MALE 2"	MALE 2"	0.382
001392	280G 2"1/2	MALE 2"1/2	MALE 2"1/2	0.654
017999	280G 3"	MALE 3"	MALE 3"	0.765
018215	280L 3"	MALE 3"	MALE 3"	0.652
018000	280G 4"	MALE 4"	MALE 4"	1.29
INEGAUX				
001309	245G 1"X3/4	MALE 1"	MALE 3/4	0
077868	245G 3/8X1/4	MALE 3/8	MALE 1/4	0.025
018015	245G 1/2X1/4	MALE 1/2	MALE 1/4	0.04
018016	245G 1/2X3/8	MALE 1/2	MALE 3/8	0.065
052455	245G 3/4X3/8	MALE 3/4"	MALE 3/8"	0.087
001311	245G 3/4X1/2	MALE 3/4	MALE 1/2	0.09
001308	245G 1"X1/2	MALE 1"	MALE 1/2	0.129
018017	245G 1"1/4X1/2	MALE 1"1/4	MALE 1/2	0.232
018018	245G 1"1/4X3/4	MALE 1"1/4	MALE 3/4	0.165
018019	245G 1"1/4X1"	MALE 1"1/4	MALE 1"	0.17
018021	245G 1"1/2X3/4	MALE 1"1/2	MALE 3/4	0.24
018022	245G 1"1/2X1"	MALE 1"1/2	MALE 1"	0.23
018023	245G 1"1/2X1"1/4	MALE 1"1/2	MALE 1"1/4	0.273
018024	245G 2"X1"	MALE 2"	MALE 1"	0.476
018025	245G 2"X1"1/4	MALE 2"	MALE 1"1/4	0.446
018026	245G 2"X1"1/2	MALE 2"	MALE 1"1/2	0.38
049420	245G 2"1/2X1"1/2	MALE 2"1/2	MALE 1"1/2	0.66
001310	245G 2"1/2X2"	MALE 2"1/2	MALE 2"	0.665
057223	245G 3"X2"	MALE 3"	MALE 2"	0.99

Manchon femelle x femelle



Manchon femelle x femelle

Utilisations : Fluides courants compatibles.

Matière : Fonte galvanisée

Limites de températures et PMS :

De -20°C à +120°C : PMS = 25 Bars

De +120°C à +300°C : PMS = 20 Bars

Code	Référence	D1	D2	Poids
EGAUX				
090106	240G 2"X1"1/2	FEM 2"	FEM 1"1/2	0.442
001341	270G 1/4	FEM 1/4	FEM 1/4	0.035
001344	270G 3/8	FEM 3/8	FEM 3/8	0.047
001340	270G 1/2	FEM 1/2	FEM 1/2	0.059
001343	270G 3/4	FEM 3/4	FEM 3/4	0.096
001337	270G 1"	FEM 1"	FEM 1"	0.14
001339	270G 1"1/4	FEM 1"1/4	FEM 1"1/4	0.202
001338	270G 1"1/2	FEM 1"1/2	FEM 1"1/2	0.329
001342	270G 2"	FEM 2"	FEM 2"	0.413
018001	270G 2"1/2	FEM 2"1/2	FEM 2"1/2	0.635
018002	270G 3"	FEM 3"	FEM 3"	0.921
001345	270G 4"	FEM 4"	FEM 4"	1.455
INEGAUX				
001271	240G 3/8X1/4	FEM 3/8	FEM 1/4	0.04
001264	240G 1/2X1/4	FEM 1/2	FEM 1/4	0.059
001265	240G 1/2X3/8	FEM 1/2	FEM 3/8	0.061
001270	240G 3/4X3/8	FEM 3/4	FEM 3/8	0.085
001269	240G 3/4X1/2	FEM 3/4	FEM 1/2	0.08
052453	240G 1"X3/8	FEM 1"	FEM 3/8"	0.14
001262	240G 1"X1/2	FEM 1"	FEM 1/2	0.145
001263	240G 1"X3/4	FEM 1"	FEM 3/4	0.149
084791	240G 1"1/4X3/8	FEM 1"1/4	FEM 3/8"	0.235
018027	240G 1"1/4X1/2	FEM 1"1/4	FEM 1/2	0.223
018028	240G 1"1/4X3/4	FEM 1"1/4	FEM 3/4	0.23
001266	240G 1"1/4X1"	FEM 1"1/4	FEM 1"	0.253
001260	240G 1"1/2X1/2	FEM 1"1/2	FEM 1/2	0.22
001261	240G 1"1/2X3/4	FEM 1"1/2	FEM 3/4	0.287
001258	240G 1"1/2X1"	FEM 1"1/2	FEM 1"	0.3
001259	240G 1"1/2X1"1/4	FEM 1"1/2	FEM 1"1/4	0.304
001267	240G 2" X 1"1/2	FEM 2"	FEM 1"1/2	0
018029	240G 2"X1/2	FEM 2"	FEM 1/2	0.31
018030	240G 2"X3/4	FEM 2"	FEM 3/4	0.325
001268	240G 2"X1"	FEM 2"	FEM 1"	0.355
018031	240G 2"X1"1/4	FEM 2"	FEM 1"1/4	0.407

Code	Référence	D1	D2	Poids
018032	240G 2"1/2X1"1/4	FEM 2"1/2	FEM 1"1/4	0.592
018033	240G 2"1/2X1"1/2	FEM 2"1/2	FEM 1"1/2	0.605
018035	240G 2"1/2X2"	FEM 2"1/2	FEM 2"	0.63
018036	240G 3"X1"1/2	FEM 3"	FEM 1"1/2	0.73
018037	240G 3"X2"	FEM 3"	FEM 2"	0.73
018038	240G 3"X2"1/2	FEM 3"	FEM 2"1/2	0.8
018039	240G 4"X2"	FEM 4"	FEM 2"	1.2
018041	240G 4"X2"1/2	FEM 4"	FEM 2"1/2	1.2
001272	240G 4"X3"	FEM 4"	FEM 3"	1.2

Manchon réduit male x femelle



Manchon réduit male x femelle

Utilisations : Fluides courants compatibles.

Matière : Fonte galvanisée

Limites de températures et PMS :

De -20°C à +120°C : PMS = 25 Bars

De +120°C à +300°C : PMS = 20 Bars

Code	Référence	D1	D2	Poids
MALEXFEM				
001285	241G 1/4X1/8	MALE 1/4	FEM 1/8	0
001296	241G 3/8X1/4	MALE 3/8	FEM 1/4	0.019
001283	241G 1/2X1/4	MALE 1/2	FEM 1/4	0.038
001284	241G 1/2X3/8	MALE 1/2	FEM 3/8	0.039
031017	241G 3/4X1/4	MALE 3/4	FEM 1/4	0.072
001295	241G 3/4X3/8	MALE 3/4	FEM 3/8	0.07
001294	241G 3/4X1/2	MALE 3/4	FEM 1/2	0.06
001286	241G 1"X3/8	MALE 1"	FEM 3/8"	0.1
001280	241G 1"X1/2	MALE 1"	FEM 1/2	0.108
001281	241G 1"X3/4	MALE 1"	FEM 3/4	0.082
001279	241G 1"1/4X3/8	MALE 1"1/4	FEM 3/8"	0.209
001277	241G 1"1/4X1/2	MALE 1"1/4	FEM 1/2	0.18
001278	241G 1"1/4X3/4	MALE 1"1/4	FEM 3/4	0.18
001276	241G 1"1/4X1"	MALE 1"1/4	FEM 1"	0.17
018003	241G 1"1/2X1/2	MALE 1"1/2	FEM 1/2	0.22
001275	241G 1"1/2X3/4	MALE 1"1/2	FEM 3/4	0.24
001273	241G 1"1/2X1"	MALE 1"1/2	FEM 1"	0.18
001274	241G 1"1/2X1"1/4	MALE 1"1/2	FEM 1"1/4	0.16
018004	241G 2"X1/2	MALE 2"	FEM 1/2	0.4
018005	241G 2"X3/4	MALE 2"	FEM 3/4	0.4
001287	241G 2"X1"	MALE 2"	FEM 1"	0.41
001291	241G 2"X1"1/4	MALE 2"	FEM 1"1/4	0.33
001288	241G 2"X1"1/2	MALE 2"	FEM 1"1/2	0.25
018006	241G 2"1/2X1/2	MALE 2"1/2	FEM 1/2	0.7
018007	241G 2"1/2X3/4	MALE 2"1/2	FEM 3/4	0.7
018008	241G 2"1/2X1"1/4	MALE 2"1/2	FEM 1"1/4	0.6
018009	241G 2"1/2X1"1/2	MALE 2"1/2	FEM 1"1/2	0.648
001289	241G 2"1/2X2"	MALE 2"1/2	FEM 2"	0.51
001292	241G 3"X1"	MALE 3"	FEM 1"	1
018010	241G 3"X1"1/4	MALE 3"	FEM 1"1/4	0.82
018011	241G 3"X1"1/2	MALE 3"	FEM 1"1/2	0.82
018012	241G 3"X2"	MALE 3"	FEM 2"	1
001293	241G 3"X2"1/2	MALE 3"	FEM 2"1/2	0.545
001290	241G 2"1/2X1"	MALE 2"1/2	FEM 1"	0.59

Code	Référence	D1	D2	Poids
018013	241G 4"X2"	MALE 4"	FEM 2"	1.5
018014	241G 4"X2"1/2	MALE 4"	FEM 2"1/2	1.2
001297	241G 4"X3"	MALE 4"	FEM 3"	1.2
038721	241G 4"X1"1/2	MALE 4"	FEM 1"1/2	1.54

Manchon réduit femelle x male



Manchon réduit femelle x male

Utilisations : Fluides courants compatibles.

Matière : Fonte galvanisée

Limites de températures et PMS :

De -20°C à +120°C : PMS = 25 Bars

De +120°C à +300°C : PMS = 20 Bars

Code	Référence	D1	D2	Poids
		MALEXFEM		
039902	246G 1/2X3/8	MALE 3/8"	FEM 1/2"	0.068
018044	246G 3/4X1/2	MALE 1/2"	FEM 3/4"	0.104
018046	246G 1"X1/2	MALE 1/2"	FEM 1"	0.144
024588	246G 1"1/4X1/2	MALE 1/2"	FEM 1"1/4"	0.205
018048	246G 1"X3/4	MALE 3/4"	FEM 1"	0.12
018050	246G 1"1/4X3/4	MALE 3/4"	FEM 1"1/4"	0.244
018051	246G 1"1/4X1"	MALE 1"	FEM 1"1/4"	0.245
018054	246G 1"1/2X1"	MALE 1"	FEM 1"1/2"	0.295
018055	246G 1"1/2X1"1/4	MALE 1"1/4"	FEM 1"1/2"	0.303
080907	246G 2"X1"1/4	MALE 1"1/4"	FEM 2"	0.303
039914	246G 2"X1"1/2	MALE 1"1/2"	FEM 2"	0.44

Union femelle x femelle - joint conique

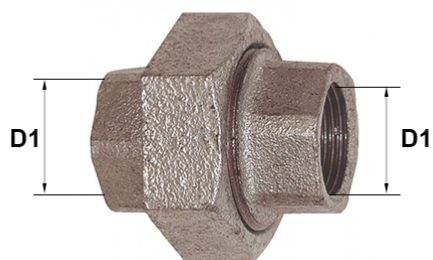

Union femelle x femelle - joint conique

Utilisations : Fluides courants compatibles.

Matière : Fonte galvanisée

Limites de températures et PMS :

De -20°C à +120°C : PMS = 25 Bars

De +120°C à +300°C : PMS = 20 Bars

Code	Référence	D1	D2	Poids
		FEMXFEM		
018121	340G 1/4	FEM 1/4		0.166
001817	340G 3/8	FEM 3/8		0.205
001812	340G 1/2	FEM 1/2		0.24
001816	340G 3/4	FEM 3/4		0.316
001809	340G 1"	FEM 1"		0.556
001811	340G 1"1/4	FEM 1"1/4		0.543
001810	340G 1"1/2	FEM 1"1/2		0.88
001813	340G 2"	FEM 2"		1.24
001814	340G 2"1/2	FEM 2"1/2		2.01
001815	340G 3"	FEM 3"		2.765
018122	340G 4"	FEM 4"		4.5

Union male x femelle joint conique

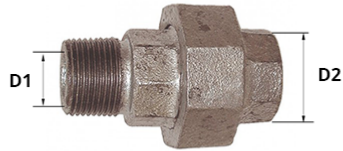

Union male x femelle joint conique

Utilisations : Fluides courants compatibles.

Matière : Fonte galvanisée

Limites de températures et PMS :

De -20°C à +120°C : PMS = 25 Bars

De +120°C à +300°C : PMS = 20 Bars

Code	Référence	D1	D2	Poids
MALEXFEM				
018123	341G 1/4	MALE 1/4	FEM 1/4	0.118
018124	341G 3/8	MALE 3/8	FEM 3/8	0.16
001823	341G 1/2	MALE 1/2	FEM 1/2	0.2
001827	341G 3/4	MALE 3/4	FEM 3/4	0.302
001820	341G 1"	MALE 1"	FEM 1"	0.4
001822	341G 1"1/4	MALE 1"1/4	FEM 1"1/4	0.66
001821	341G 1"1/2	MALE 1"1/2	FEM 1"1/2	0.8
001824	341G 2"	MALE 2"	FEM 2"	1.15
001825	341G 2"1/2	MALE 2"1/2	FEM 2"1/2	2.1
001826	341G 3"	MALE 3"	FEM 3"	2.5
077877	341G 4"	MALE 4"	FEM 4"	4.5

Bobine acier galvanisé



Bobine acier galvanisé

Utilisations : Fluides courants compatibles.

Matière : Fonte galvanisée

Limites de températures et PMS :

De -20°C à +120°C : PMS = 25 Bars

De +120°C à +300°C : PMS = 20 Bars

Code	Référence	D1	D2	Poids
MALEXMALE				
045366	530G 1/4 LG50	MALE 1/4"	MALE 1/4"	0.025
077879	530G 1/4 LG 60	MALE 1/4"	MALE 1/4"	0.034
035571	530G 1/4 LG100	MALE 1/4"	MALE 1/4"	0.056
045368	530G 1/4 LG120	MALE 1/4"	MALE 1/4"	0.074
045370	530G 1/4 LG150	MALE 1/4"	MALE 1/4"	0.092
022469	530G 1/4 LG200	MALE 1/4"	MALE 1/4"	0.132
045371	530G 1/4 LG300	MALE 1/4"	MALE 1/4"	0.185
045367	530G 1/4 LG80	MALE 1/4"	MALE 1/4"	0
018134	530G 3/8 LG 50	MALE 3/8	MALE 3/8	0.036
077878	530G 3/8 LG 60	MALE 3/8	MALE 3/8	0.047
018135	530G 3/8 LG 80	MALE 3/8	MALE 3/8	0.06
018136	530G 3/8 LG 100	MALE 3/8	MALE 3/8	0.076
018138	530G 3/8 LG 150	MALE 3/8	MALE 3/8	0.1
018139	530G 3/8 LG 180	MALE 3/8	MALE 3/8	0.13
018142	530G 3/8 LG 200	MALE 3/8	MALE 3/8	0.14
002914	530G 3/8 LG 300	MALE 3/8	MALE 3/8	0.22
018137	530G 3/8 LG 120	MALE 3/8	MALE 3/8	0
002896	530G 1/2 LG 50	MALE 1/2	MALE 1/2	0.043
002897	530G 1/2 LG 60	MALE 1/2	MALE 1/2	0.06
018143	530G 1/2 LG 80	MALE 1/2	MALE 1/2	0.076
002894	530G 1/2 LG 100	MALE 1/2	MALE 1/2	0.1
018144	530G 1/2 LG 150	MALE 1/2	MALE 1/2	0.15
018145	530G 1/2 LG 180	MALE 1/2	MALE 1/2	0.19
002895	530G 1/2 LG 200	MALE 1/2	MALE 1/2	0.21
018146	530G 1/2 LG 250	MALE 1/2	MALE 1/2	0.25
018147	530G 1/2 LG 300	MALE 1/2	MALE 1/2	0.21
018149	530G 3/4 LG 50	MALE 3/4	MALE 3/4	0.058
002913	530G 3/4 LG 80	MALE 3/4	MALE 3/4	0.1
002908	530G 3/4 LG 100	MALE 3/4	MALE 3/4	0.14
002910	530G 3/4 LG 120	MALE 1/4	MALE 3/4	0.16
018152	530G 3/4 LG 150	MALE 3/4	MALE 3/4	0.225
018153	530G 3/4 LG 180	MALE 3/4	MALE 3/4	0.24
002911	530G 3/4 LG 200	MALE 3/4	MALE 3/4	0.27
002912	530G 3/4 LG 250	MALE 3/4	MALE 3/4	0.33

Code	Référence	D1	D2	Poids
018154	530G 3/4 LG 300	MALE 3/4	MALE 3/4	0.39
068813	530G 3/4 LG 500	MALE 3/4"	MALE 3/4"	0.832
018155	530G 1" LG 50	MALE 1"	MALE 1"	0.09
002886	530G 1" LG 80	MALE 1"	MALE 1"	0.15
002885	530G 1" LG 100	MALE 1"	MALE 1"	0.19
002884	530G 1" LG 120	MALE 1"	MALE 1"	0.25
018156	530G 1" LG 150	MALE 1"	MALE 1"	0.35
018157	530G 1" LG 180	MALE 1"	MALE 1"	0.36
018158	530G 1" LG 200	MALE 1"	MALE 1"	0.4
018166	530G 1" LG 250	MALE 1"	MALE 1"	0.52
018167	530G 1" LG 300	MALE 1"	MALE 1"	0.62
064853	530G 1"1/2 LG 500	MALE 1"1/2	MALE 1"1/2	1.56
064854	530G 1" LG 500	MALE 1"	MALE 1"	1.15
018174	530G 1"1/4 LG 50	MALE 1"1/4	MALE 1"1/4	1.36
018177	530G 1"1/4 LG 80	MALE 1"1/4	MALE 1"1/4	0.19
002891	530G 1"1/4 LG 100	MALE 1"1/4	MALE 1"1/4	0.25
002890	530G 1"1/4 LG 120	MALE 1"1/4	MALE 1"1/4	0.25
018178	530G 1"1/4 LG 150	MALE 1"1/4	MALE 1"1/4	0.38
018179	530G 1"1/4 LG 180	MALE 1"1/4	MALE 1"1/4	0.5
018180	530G 1"1/4 LG 200	MALE 1"1/4	MALE 1"1/4	0.55
018181	530G 1"1/4 LG 250	MALE 1"1/4	MALE 1"1/4	0.68
002892	530G 1"1/4 LG 300	MALE 1"1/4	MALE 1"1/4	0.84
064864	530G 1"1/4 LG 500	MALE 1"1/4	MALE 1"1/4	1.632
100270	530G 1"1/4 LG 1500	MALE 1"1/4	MALE 1"1/4	5.022
100271	530G 1"1/4 LG 2000	MALE 1"1/4	MALE 1"1/4	6.717
100272	530G 1"1/4 LG 3000	MALE 1"1/4	MALE 1"1/4	9
018182	530G 1"1/2 LG 50	MALE 1"1/2	MALE 1"1/2	0.12
018183	530G 1"1/2 LG 80	MALE 1"1/2	MALE 1"1/2	0.22
002889	530G 1"1/2 LG 100	MALE 1"1/2	MALE 1"1/2	0.29
002887	530G 1"1/2 LG 120	MALE 1"1/2	MALE 1"1/2	0.36
018184	530G 1"1/2 LG 150	MALE 1"1/2	MALE 1"1/2	0.5
018185	530G 1"1/2 LG 180	MALE 1"1/2	MALE 1"1/2	0.58
002888	530G 1"1/2 LG 200	MALE 1"1/2	MALE 1"1/2	0.62
018186	530G 1"1/2 LG 250	MALE 1"1/2	MALE 1"1/2	0.84
018187	530G 1"1/2 LG 300	MALE 1"1/2	MALE 1"1/2	0.985
018188	530G 2" LG 60	MALE 2"	MALE 2"	0.22
002900	530G 2" LG 80	MALE 2"	MALE 2"	0.28
002898	530G 2" LG 100	MALE 2"	MALE 2"	0.4
018190	530G 2" LG 120	MALE 2"	MALE 2"	0.4
018191	530G 2" LG 150	MALE 2"	MALE 2"	0.65
018192	530G 2" LG 180	MALE 2"	MALE 2"	0.8
002899	530G 2" LG 200	MALE 2"	MALE 2"	0.825
018193	530G 2" LG 250	MALE 2"	MALE 2"	1.08
018194	530G 2" LG 300	MALE 2"	MALE 2"	1.26
002902	530G 2"1/2 LG 100	MALE 2"1/2	MALE 2"1/2	0.5
018195	530G 2"1/2 LG 120	MALE 2"1/2	MALE 2"1/2	0.63
018196	530G 2"1/2 LG 150	MALE 2"1/2	MALE 2"1/2	0.82
018197	530G 2"1/2 LG 180	MALE 2"1/2	MALE 2"1/2	1
002901	530G 2"1/2 LG 200	MALE 2"1/2	MALE 2"1/2	1.1
018198	530G 2"1/2 LG 300	MALE 2"1/2	MALE 2"1/2	1.83
002907	530G 3" LG 80	MALE 3"	MALE 3"	0.46
002903	530G 3" LG 100	MALE 3"	MALE 3"	0.62
002904	530G 3" LG 120	MALE 3"	MALE 3"	0.72
002905	530G 3" LG 150	MALE 3"	MALE 3"	0.99
002906	530G 3" LG 200	MALE 3"	MALE 3"	1.28
018168	530G 3" LG 250	MALE 3"	MALE 3"	1.51
018169	530G 3" LG 300	MALE 3"	MALE 3"	1.94
002916	530G 4" LG 100	MALE 4"	MALE 4"	0.89
018170	530G 4" LG 150	MALE 4"	MALE 4"	1.33
002915	530G 4" LG 200	MALE 4"	MALE 4"	1.9

Code	Référence	D1	D2	Poids
018171	530G 4" LG 250	MALE 4"	MALE 4"	2.44
018172	530G 4" LG 300	MALE 4"	MALE 4"	2.9
061488	530G 3" LG 1500	MALE 3"	MALE 3"	12.58
097116	530G 4" LG 1000	MALE 4"	MALE 4"	15.639
097117	530G 4" LG 1500	MALE 4"	MALE 4"	23.674

Coude 90° femelle x femelle

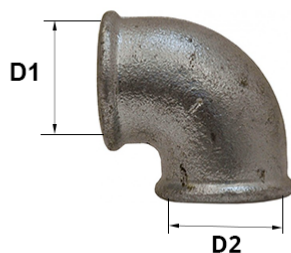

Coude 90° femelle x femelle

Utilisations : Fluides courants compatibles.

Matière : Fonte galvanisée

Limites de températures et PMS :

De -20°C à +120°C : PMS = 25 Bars

De +120°C à +300°C : PMS = 20 Bars

Code	Référence	D1	D2	Poids
EGAUX				
004304	90G 1/4	FEM 1/4	FEM 1/4	0.04
004308	90G 3/8	FEM 3/8	FEM 3/8	0.063
004303	90G 1/2	FEM 1/2	FEM 1/2	0.099
004307	90G 3/4	FEM 3/4	FEM 3/4	0.163
004300	90G 1"	FEM 1"	FEM 1"	0.2
004302	90G 1"1/4	FEM 1"1/4	FEM 1"1/4	0.388
004301	90G 1"1/2	FEM 1"1/2	FEM 1"1/4	0.353
004305	90G 2"	FEM 2"	FEM 2"	0.682
004306	90G 2"1/2	FEM 2"1/2	FEM 2"1/2	1.111
018067	90G 3"	FEM 3"	FEM 3"	1.5
018068	90G 4"	FEM 4"	FEM 4"	2.235
INEGAUX				
018090	90RG 1/2X3/8	FEM 1/2	FEM 3/8	0.068
018091	90RG 3/4X1/2	FEM 3/4	FEM 1/2	0.116
018092	90RG 1"X1/2	FEM 1"	FEM 1/2	0.142
018093	90RG 1"X3/4	FEM 1"	FEM 3/4	0.149
018095	90RG 1"1/4X3/4	FEM 1"1/4	FEM 3/4	0.202
018096	90RG 1"1/4X1"	FEM 1"1/4	FEM 1"	0.31
018097	90RG 1"1/2X1"	FEM 1"1/2	FEM 1"	0.341
018098	90RG 1"1/2X1"1/4	FEM 1"1/2	FEM 1"1/4	0.74
018099	90RG 2"X1"	FEM 2"	FEM 1"	0.46
018101	90RG 2"X1"1/4	FEM 2"	1"1/4	0.6
018102	90RG 2"X1"1/2	FEM 2"	FEM 1"1/2	0.605

Coude 90° male x femelle

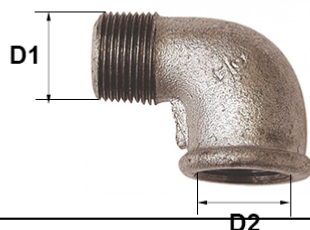

Coude 90° male x femelle

Utilisations : Fluides courants compatibles.

Matière : Fonte galvanisée

Limites de températures et PMS :

De -20°C à +120°C : PMS = 25 Bars

De +120°C à +300°C : PMS = 20 Bars

Code	Référence	D1	D2	Poids
EGAUX				
004334	92G 1/4	MALE 1/4	FEM 1/4	0.04
004339	92G 3/8	MALE 3/8	FEM 3/8	0.065
004333	92G 1/2	MALE 1/2	FEM 1/2	0.1
004338	92G 3/4	MALE 3/4	FEM 3/4	0.157
004330	92G 1"	MALE 1"	FEM 1"	0.246
004332	92G 1"1/4	MALE 1"1/4	FEM 1"1/4	0.379
004331	92G 1"1/2	MALE 1"1/2	FEM 1"1/2	0.429
004335	92G 2"	MALE 2"	FEM 2"	0.665
004336	92G 2"1/2	MALE 2"1/2	FEM 2"1/2	1
004337	92G 3"	MALE 3"	FEM 3"	1.5
018069	92G 4"	MALE 4"	FEM 4"	2.76

Coude 90° union femelle x femelle joint conique

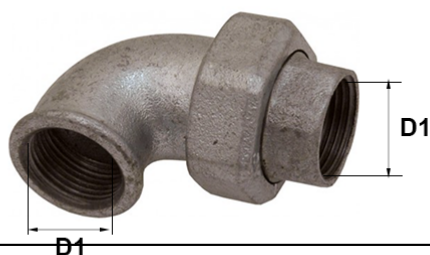

Coude 90° union femelle x femelle joint conique

Utilisations : Fluides courants compatibles.

Matière : Fonte galvanisée

Limites de températures et PMS :

De -20°C à +120°C : PMS = 25 Bars

De +120°C à +300°C : PMS = 20 Bars

Code	Référence	D1	D2	Poids
FEMXFEM				
018115	96G 1/2	FEM 1/2		0.37
018116	96G 3/4	FEM 3/4		0.24
018117	96G 1"	FEM 1"		0.53
018118	96G 1"1/4	FEM 1"1/4		0.81
018119	96G 1"1/2	FEM 1"1/2		1.5
018120	96G 2"	FEM 2"		2.295

Coude 90° union male x femelle joint conique



Coude 90° union male x femelle joint conique

Utilisations : Fluides courants compatibles.

Matière : Fonte galvanisée

Limites de températures et PMS :

De -20°C à +120°C : PMS = 25 Bars

De +120°C à +300°C : PMS = 20 Bars

Code	Référence	D1	D2	Poids
MALEXFEM				
018125	98G 1/2	MALE 1/2	FEM 1/2	0.37
004379	98G 3/4	MALE 3/4	FEM 3/4	0.24
018127	98G 1"	MALE 1"	FEM 1"	0.53
018128	98G 1"1/4	MALE 1"1/4	FEM 1"1/4	0.81
018130	98G 1"1/2	MALE 1"1/2	FEM 1"1/2	1.5
018131	98G 2"	MALE 2"	FEM 2"	2.295

Coude 90° femelle x femelle grand rayon



Coude 90° femelle x femelle grand rayon

Utilisations : Fluides courants compatibles.

Matière : Fonte galvanisée

Limites de températures et PMS :

De -20°C à +120°C : PMS = 25 Bars

De +120°C à +300°C : PMS = 20 Bars

Code	Référence	D1	D2	Poids
FEMXFEM				
043229	2G 1/4	FEM 1/4"		0.068
052467	2G 1/2	FEM 1/2		0.136
052468	2G 3/4	FEM 3/4		0.157
052469	2G 1"	FEM 1"		0.372
052470	2G 1"1/4	FEM 1"1/4		0.379
052471	2G 1"1/2	FEM 1"1/2		0.775
052472	2G 2"	FEM 2"		1.41
099045	2G 2"1/2	FEM 2"1/2		2.3
080905	2G 3"	FEM 3"		3.61
055138	2G 4"	FEM 4"		2.76

Coude 90° male x femelle grand rayon



Coude 90° male x femelle grand rayon

Utilisations : Fluides courants compatibles.

Matière : Fonte galvanisée

Limites de températures et PMS :

De -20°C à +120°C : PMS = 25 Bars

De +120°C à +300°C : PMS = 20 Bars

Code	Référence	D1	D2	Poids
MALEXFEM				
043228	1G 1/4	MALE 1/4"	FEM 1/4"	0.051
077869	1G 3/8	MALE 3/8"	FEM 3/8"	0.08
052462	1G 1/2	MALE 1/2"	FEM 1/2"	0.125
052463	1G 3/4	MALE 3/4"	FEM 3/4"	0.208
052464	1G 1"	MALE 1"	FEM 1"	0.356
000967	1G 1"1/4	MALE 1"1/4"	FEM 1"1/4"	0.518
052465	1G 1"1/2	MALE 1"1/2"	FEM 1"1/2"	0.733
052466	1G 2"	MALE 2"	FEM 2"	1.155

Coude 45° femelle x femelle

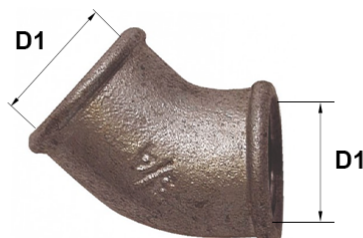

Coude 45° femelle x femelle

Utilisations : Fluides courants compatibles.

Matière : Fonte galvanisée

Limites de températures et PMS :

De -20°C à +120°C : PMS = 25 Bars

De +120°C à +300°C : PMS = 20 Bars

Code	Référence	D1	D2	Poids
FEMXFEM				
018082	120G 1/2	FEM 1/2"		0.08
000352	120G 3/4	FEM 3/4"		0.13
018083	120G 1"	FEM 1"		0.195
018084	120G 1"1/4	FEM 1"1/4"		0.25
018085	120G 1"1/2	FEM 1"1/2"		0.37
018086	120G 2"	FEM 2"		0.605
018087	120G 2"1/2	FEM 2"1/2"		2
018088	120G 3"	FEM 3"		1.3
018089	120G 4"	FEM 4"		2.8

Coude 45° male x femelle



Coude 45° male x femelle

Utilisations : Fluides courants compatibles.

Matière : Fonte galvanisée

Limites de températures et PMS :

De -20°C à +120°C : PMS = 25 Bars

De +120°C à +300°C : PMS = 20 Bars

Code	Référence	D1	D2	Poids
		MALEXFEM		
109816	40G 1/2	MALE 1/2	FEM 1/2	0.09
002043	40G 3/4	MALE 3/4	FEM 3/4	0.16
077871	40G 1"	MALE 1"	FEM 1"	0.23
037517	40G 1"1/4	MALE 1"1/4	FEM 1"1/4	0.385
022113	40G 1"1/2	MALE 1"1/2	FEM 1"1/2	0.485
002042	40G 2"	MALE 2"	FEM 2"	0.92
098458	40G 2"1/2	MALE 2"1/2	FEM 2"1/2	1.35
094105	40G 3"	MALE 3"	FEM 3"	2

Te égal femelle



Te égal femelle

Utilisations : Fluides courants compatibles.

Matière : Fonte galvanisée

Limites de températures et PMS :

De -20°C à +120°C : PMS = 25 Bars

De +120°C à +300°C : PMS = 20 Bars

Code	Référence	D1	D2	Poids
EGAUX				
000380	130G 1/4	FEM 1/4	FEM 1/4	0.06
000383	130G 3/8	FEM 3/8	FEM 3/8	0.089
000379	130G 1/2	FEM 1/2	FEM 1/2	0.1
000382	130G 3/4	FEM 3/4	FEM 3/4	0.243
000376	130G 1"	FEM 1"	FEM 1"	0.25
000378	130G 1"1/4	FEM 1"1/4	FEM 1"1/4	0.548
000377	130G 1"1/2	FEM 1"1/2	FEM 1"1/2	0.643
000381	130G 2"	FEM 2"	FEM 2"	0.848
018064	130G 2"1/2	FEM 2"1/2	FEM 2"1/2	1.553
018065	130G 3"	FEM 3"	FEM 3"	2.026
018066	130G 4"	FEM 4"	FEM 4"	3.155
INEGAUX				
018104	130RG 3/4X1/2	FEM 3/4	FEM 1/2	0.15
018105	130RG 1"X1/2	FEM 1"	FEM 1/2	0.255
018106	130RG 1"X3/4	FEM 1"	FEM 3/4	0.218
018107	130RG 1"1/4X1/2	FEM 1"1/4	FEM 1/2	0.325
018108	130RG 1"1/4X3/4	FEM 1"1/4	FEM 3/4	0.35
018109	130RG 1"1/4X1"	FEM 1"1/4	FEM 1"	0.385
067159	130RG 1"1/2X1/2	FEM 1"1/2	FEM 1/2"	0.37
000388	130RG 1"1/2X3/4	FEM 1"1/2	FEM 3/4	0.37
018110	130RG 1"1/2X1"	FEM 1"1/2	FEM 1"	0.445
018111	130RG 1"1/2X1"1/4	FEM 1"1/2	FEM 1"1/4	0.8
018112	130RG 2"X1"	FEM 2"	FEM 1"	0.665
018113	130RG 2"X1"1/4	FEM 2"	FEM 1"1/4	0.743
018114	130RG 2"X1"1/2	FEM 2"	FEM 1"1/2	0.735

Croix égale femelle

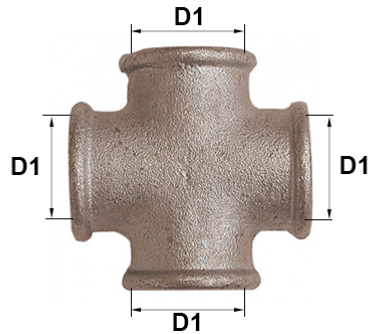

Croix égale femelle

Utilisations : Fluides courants compatibles.

Matière : Fonte galvanisée

Limites de températures et PMS :

De -20°C à +120°C : PMS = 25 Bars

De +120°C à +300°C : PMS = 20 Bars

Code	Référence	D1	D2	Poids
		EGAUX		
018070	180G 1/2	FEM 1/2		0.179
018071	180G 3/4	FEM 3/4		0.287
000877	180G 1"	FEM 1"		0.399
018072	180G 1"1/4	FEM 1"1/4		0.594
018073	180G 1"1/2	FEM 1"1/2		0.715
018074	180G 2"	FEM 2"		1.053
018075	180G 2"1/2	FEM 2"1/2		1.53
018077	180G 3"	FEM 3"		2.38
018078	180G 4"	FEM 4"		4.21

16- RACCORD ACIER NOIR À SOUDER



1/2 mamelon à souder

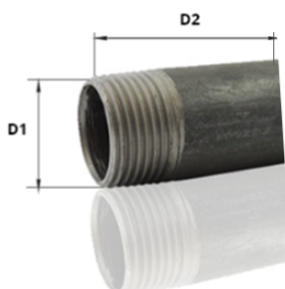

1/2 mamelon à souder

Longueur : 60mm

Pression : PN 20 bar

Matières : Acier S195T

Raccordements : Filetage selon ISO 7-1 (BSPT)

Code	Référence	D1	D2	Poids
045831	1/2 BOBINE ACIER 1/4	1/2	60mm	0
045832	1/2 BOBINE ACIER 3/8	1/2	60mm	0
045833	1/2 BOBINE ACIER 1/2	1/2	60mm	0
045834	1/2 BOBINE ACIER 3/4	1/2	60mm	0
045835	1/2 BOBINE ACIER 1"	1/2	60mm	0
045836	1/2 BOBINE ACIER 1"1/4	1/2	60mm	0
045837	1/2 BOBINE ACIER 1"1/2	1/2	60mm	0
045838	1/2 BOBINE ACIER 2"	1/2	60mm	0
045839	1/2 BOBINE ACIER 2"1/2	1/2	60mm	0
045840	1/2 BOBINE ACIER 3"	1/2	60mm	0
045841	1/2 BOBINE ACIER 4"	1/2	60mm	0
079642	1/2 BOBINE ACIER 3/4 L100	1/2	160mm	0

1/2 manchon acier à souder

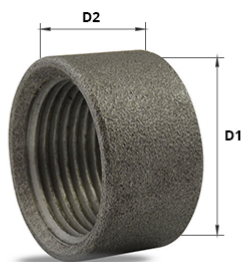

1/2 manchon acier à souder

Pression : PN 20 bar

Matière : Acier S195T

Raccordements : Taraudage selon la norme ISO 7-1 (BSPT), taraudage traversant parallèle (Rp)

Code	Référence	D1	D2	Poids
045824	1/2 MANCHON ACIER 1/2	1/2	15mm	0
045825	1/2 MANCHON ACIER 3/4	1/2	17mm	0
045826	1/2 MANCHON ACIER 1"	1/2	20mm	0
045827	1/2 MANCHON ACIER 1"1/4	1/2	22mm	0
045828	1/2 MANCHON ACIER 1"1/2	1/2	22mm	0
045829	1/2 MANCHON ACIER 2"	1/2	26mm	0
045830	1/2 MANCHON ACIER 2"1/2	1/2	30mm	0

Manchon acier à souder

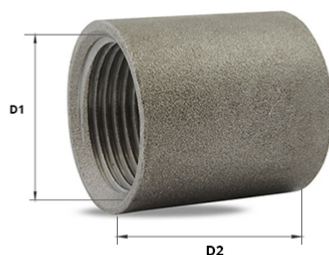

Manchon acier à souder

Pression : PN 20 bar

Matière : Acier S195T

Raccordements : Taraudage selon la norme ISO 7-1 (BSPT), taraudage traversant parallèle (Rp)

Code	Référence	D1	D2	Poids
045811	MANCHON ACIER 1/8	FEM 1/8	17mm	0
045812	MANCHON ACIER 1/4	FEM 1/4	25mm	0
045813	MANCHON ACIER 3/8	FEM 3/8	26mm	0
045814	MANCHON ACIER 1/2	FEM 1/2	26mm	0
045815	MANCHON ACIER 3/4	FEM 3/4	34mm	0
045816	MANCHON ACIER 1"	FEM 1"	43mm	0
045817	MANCHON ACIER 1"1/4	FEM 1"1/4	48mm	0
045818	MANCHON ACIER 1"1/2	FEM 1"1/2	48mm	0
045819	MANCHON ACIER 2"	FEM 2"	56mm	0
045820	MANCHON ACIER 2"1/2	FEM 2"1/2	65mm	0
045821	MANCHON ACIER 3"	FEM 3"	71mm	0
045822	MANCHON ACIER 4"	FEM 4"	83mm	0

Réduction concentrique à souder



Réduction concentrique

Matière : acier S235 ou S265

Raccordement : à souder bout-à-bout (BW)

Marquage et traçabilité : nuance de l'acier, dimensions du raccord, numéro de lot

Code	Référence	D1	D2	Poids
045725	REDUC 42.4X26.9	42.4mm	26.9mm	0
045726	REDUC 42.4X33.7	42.4mm	33.7mm	0
045727	REDUC 48.3X26.9	48.3mm	26.9mm	0
045728	REDUC 48.3X33.7	48.3mm	33.7mm	0
045730	REDUC 60.3X33.7	60.3mm	33.7mm	0
045731	REDUC 60.3X42.4	60.3mm	42.4mm	0
045732	REDUC 60.3X48.3	60.3mm	48.3mm	0
045733	REDUC 70.0X42.4	70mm	42.4mm	0
045734	REDUC 70.0X48.3	70mm	48.3mm	0
045735	REDUC 70.0X60.3	70mm	60.3mm	0
045736	REDUC 76.1X42.4	76.1mm	42.4mm	0
045737	REDUC 76.1X48.3	76.1mm	48.3mm	0
045738	REDUC 76.1X60.3	76.1mm	60.3mm	0
045739	REDUC 88.9X48.3	88.9mm	48.3mm	0
045740	REDUC 88.9X60.3	88.9mm	60.3mm	0
045741	REDUC 88.9X70.0	88.9mm	70mm	0
045742	REDUC 88.9X76.1	88.9mm	76.1mm	0
045743	REDUC 101.6X70.0	101.6mm	70mm	0
045744	REDUC 101.6X76.1	101.6mm	76.1mm	0
045748	REDUC 101.6X88.9	101.6mm	88.9mm	0
045749	REDUC 108.0X60.3	108mm	60.3mm	0
045751	REDUC 108.0X76.1	108mm	76.1mm	0
045752	REDUC 108.0X88.9	108mm	88.9mm	0
045753	REDUC 114.3X60.3	114.3mm	60.3mm	0
045756	REDUC 114.3X70.0	114.3mm	70mm	0
045757	REDEUC 114.3X76.1	114.3mm	76.1mm	0
045758	REDUC 114.3X88.9	114.3mm	88.9mm	0
045759	REDUC 114.3X101.6	114.3mm	101.6mm	0
045760	REDUC 133.0X76.1	133mm	76.1mm	0
045761	REDUC 133.0X88.9	133mm	88.9mm	0
045763	REDUC 133.0X114.3	133mm	114.3mm	0
045764	REDUC 139.7X76.1	139.7mm	76.1mm	0
045765	REDUC 139.7X88.9	139.7mm	88.9mm	0
045766	REDUC 139.7X101.6	139.7mm	101.6mm	0
045767	REDUC 139.7X108.0	139.7mm	108mm	0
045769	REDUC 139.7X114.3	139.7mm	114.3mm	0

Code	Référence	D1	D2	Poids
045770	REDUC 139.7X133.0	139.7mm	133mm	0
045771	REDUC 159.0X88.9	159mm	88.9mm	0
045772	REDUC 159.0X108.0	159mm	108mm	0
045773	REDUC 159.0X114.3	159mm	114.3mm	0
045774	REDUC 159.0X133.0	159mm	133mm	0
045775	REDUC 159.0X139.7	159mm	139.7mm	0
045776	REDUC 168.3X88.9	168.3mm	88.9mm	0
045778	REDUC 168.3X101.6	168.3mm	101.6mm	0
045779	REDUC 168.3X114.3	168.3mm	114.3mm	0
045780	REDUC 168.3X133.0	168.3mm	133mm	0
045781	REDUC 168.3X139.7	168.3mm	139.7mm	0
045782	REDUC 168.3X159.0	168.3mm	159mm	0
045783	REDUC 193.7X114.3	193.7mm	114.3mm	0
045784	REDUC 193.7X133.0	193.7mm	133mm	0
045785	REDUC 193.7X139.7	193.7mm	139.7mm	0
045786	REDUC 193.7X168.3	193.7mm	168.3mm	0
045787	REDUC 219.1X114.3	219.1mm	114.3mm	0
045788	REDUC 219.1X133.0	219.1mm	133mm	0
045789	REDUC 219.1X139.7	219.1mm	139.7mm	0
045790	REDUC 219.1X159.0	219.1mm	159mm	0
045791	REDUC 219.1X168.3	219.1mm	168.3mm	0
045745	REDUC 48.3X42.4	48.3mm	42.4mm	0

Coude 3D à souder



Coude 3D à souder

Matière : acier S235 ou S265

Raccordement : à souder bout-à-bout (BW)

Marquage et traçabilité : nuance de l'acier, dimensions du raccord, numéro de lot

Code	Référence	D1	D2	Poids
045686	COUDE 3D 21.3X2.0	21.3mm	2mm	0
045687	COUDE 3D 26.9X2.3	26.9mm	2.3mm	0
045481	COUDE 3D 33.7X2.3	33.7mm	2.3mm	0
044809	COUDE 3D 42,3X2,6	42.3mm	2.6mm	0
045469	COUDE 3D 48,4X2,6	48.4mm	2.6mm	0.26
006667	COUDE 3D 60,3X2,9	60.3mm	2.9mm	0.49
043197	COUDE 3D 70X2.9	70mm	2.9mm	0
006668	COUDE 3D 76,1X2,9	76.1mm	2.9mm	0.78
045480	COUDE 3D 88.9X3.2	88.9mm	3.2mm	0
043085	COUDE 3D 101.6X3.6	101.6mm	3.6mm	1.83
043086	COUDE 3D 114.3X3.6	114.3mm	3.6mm	2.35
045688	COUDE 3D 108.0X3.6	108mm	3.6mm	0
045689	COUDE 3D 133.0X4.0	133mm	4mm	0
045690	COUDE 3D 139.7X4.0	139.7mm	4mm	0
045691	COUDE 3D 159.0X4.5	159mm	4.5mm	0
045692	COUDE 3D 168.3X4.5	168.3mm	4.5mm	0
045694	COUDE 3D 193.7X5.6	193.7mm	5.6mm	0
045695	COUDE 3D 219.1X6.3	219.1mm	6.3mm	0
053576	COUDE 3D 244.5X6.3	244.5mm	6.3mm	0

Coude 5D à souder



Courbe 5D a 90°, noire

Matière : acier S235 ou S265

Raccordement : à souder bout-à-bout (BW)

Marquage et traçabilité : nuance de l'acier, dimensions du raccord, numéro de lot

Code	Référence	D1	D2	Poids
045696	COUDE 5D 26.9X2.3	26.9mm	2.3mm	0
045697	COUDE 5D 33.7X2.3	33.7mm	2.3mm	0
045698	COUDE 5D 42.4X2.6	42.4mm	2.6mm	0
045699	COUDE 5D 48.3X2.6	48.3mm	2.6mm	0
045700	COUDE 5D 60.3X2.9	60.3mm	2.9mm	0.8
045701	COUDE 5D 70.0X2.9	70mm	2.9mm	0
045702	COUDE 5D 76.1X2.9	76.1mm	2.9mm	0
045703	COUDE 5D 88.9X3.2	88.9mm	3.2mm	0
045704	COUDE 5D 101.6X3.6	101.6mm	3.6mm	0
045705	COUDE 5D 108.0X3.6	108mm	3.6mm	0
045706	COUDE 5D 114.3X3.6	114.3mm	3.6mm	0
045707	COUDE 5D 133.0X4.0	133mm	4mm	0
045708	COUDE 5D 139.7X4	139.7mm	4mm	0
045709	COUDE 5D 159.0X4.5	159mm	4.5mm	0
045710	COUDE 5D 168.3X4.5	168.3mm	4.5mm	0
045711	COUDE 5D 193.7X5.6	193.7mm	5.6mm	0
045712	COUDE 5D 219.1X6.3	219.1mm	6.3mm	0

Te égal à souder



Te égal à souder

Matière : acier S235 ou S265

Raccordement : à souder bout-à-bout (BW)

Marquage et traçabilité : nuance de l'acier, dimensions du raccord, numéro de lot

Code	Référence	D1	D2	Poids
045713	TE 26.9X2.3	26.9mm	2.3mm	0
045714	TE 33.7X2.3	33.7mm	2.3mm	0
045715	TE 42.4X2.6	42.4mm	2.6mm	0
045716	TE 48.3X2.6	48.3mm	2.6mm	0
045717	TE 60.3X2.9	60.3mm	2.9mm	0
045718	TE 76.1X2.9	76.1mm	2.9mm	0
045719	TE 88.9X3.2	88.9mm	3.2mm	0
045720	TE 114.3X3.6	114.3mm	3.6mm	0
045721	TE 139.7X4	139.7mm	4mm	0
045722	TE 168.3X4.5	168.3mm	4.5mm	0
045723	TE 219.1X6.3	219.1mm	6.3mm	0

Fond bombé à souder



Fond bombé noir

Matière : acier S235 ou S265

Raccordement : à souder bout-à-bout (BW)

Marquage et traçabilité : nuance de l'acier, dimensions du raccord, numéro de lot

Code	Référence	D1	D2	Poids
045793	FOND 26.9X2.3	26.9mm	2.3mm	0
045795	FOND 33.7X2.3	33.7mm	2.3mm	0
045796	FOND 42.4X2.6	42.4mm	2.6mm	0
045797	FOND 48.3X2.6	48.3mm	2.6mm	0
045799	FOND 70.0X2.9	70mm	2.9mm	0
045800	FOND 76.1X2.9	76.1mm	2.9mm	0
045801	FOND 88.9X3.2	88.9mm	3.2mm	0
045802	FOND 101.6X3.6	101.6mm	3.6mm	0
045803	FOND 108.0X3.6	108mm	3.6mm	0
045804	FOND 114.3X3.6	114.3mm	3.6mm	0
045805	FOND 133.0X4.0	133mm	4mm	0
045806	FOND 139.7X4	139.7mm	4mm	0
045807	FOND 159.0X4.5	159mm	4.5mm	0
045808	FOND 168.3X4.5	168.3mm	4.5mm	0
045809	FOND 193.7X5.6	193.7mm	5.6mm	0
045810	FOND 219.1X6.3	219.1mm	6.3mm	0

17- COLLIERS



Collier à oreilles (zingue)

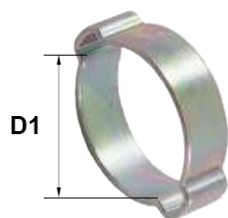

Collier a 2 oreilles (zingue) sauf précisé

Matière : acier zingué

Code	Référence	D1	D2	Poids
014670	CO 05-07	05 à 07mm		0
014681	CO 07-09	07 à 09mm		0
014682	CO 09-11	09 à 11mm		0
014683	CO 11-13	11 à 13mm		0
014684	CO 13-15	13 à 15mm		0
045167	CO 14-17	14 à 17mm		0
014685	CO 15-18	15 à 18mm		0
045165	CO 17-20	17 à 20mm		0
014686	CO 18-21	18 à 21mm		0
014687	CO 20-23	23 à 23mm		0
045168	CO 22-25	22 à 25mm		0
014688	CO 23-27	23 à 27mm		0
014689	CO 25-28	25 à 28mm		0
014690	CO 28-31	28 à 31mm		0
014691	CO 31-34	31 à 34mm		0
014692	CO 34-37	34 à 37mm		0
014693	CO 37-40	37 à 40mm		0
014694	CO 40-43	40 à 43mm		0
045171	CO 43-46	43 à 46mm		0
096217	CO 1 OREILLE 07-09	07 à 09mm		0
096220	CO 1 OREILLE 09-11	09 à 11mm		0
104110	CO 1 OREILLE 11-13	11 à 13mm		0
096470	CO 1 OREILLE 13-15	13 à 15mm		0

Collier à 1 oreille inox



Collier à 1 oreille inox

Matière : inox

Code	Référence	D1	D2	Poids
112361	CO 1 OREILLE 7.5-8.5 AVEC BAGUE INOX	7.5 à 8.5mm		0
112364	CO 1 OREILLE 8.0-9.5 AVEC BAGUE INOX	8 à 9.5mm		0
112365	CO 1 OREILLE 9-10.5 AVEC BAGUE INOX	9 à 10.5mm		0
112366	CO 1 OREILLE 10-11.5 AVEC BAGUE INOX	10 à 11.5mm		0

Collier à oreilles (inox)



Collier à oreilles (inox)

Matière : Acier inox

Code	Référence	D1	D2	Poids
045172	CO 07-09 INOX	07 à 09mm		0
045173	CO 09-11 INOX	09 à 11mm		0
045174	CO 11-13 INOX	11 à 13mm		0
045175	CO 13-15 INOX	13 à 15mm		0
045176	CO 15-18 INOX	15 à 18mm		0
045177	CO 17-20 INOX	17 à 20mm		0
036724	CO 18-21 INOX	18 à 21mm		0

Collier acier à bande pleine 9mm

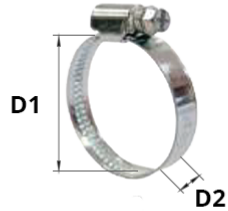

Collier acier à bande pleine 9mm

Matière : acier

Code	Référence	D1	D2	Poids
014620	CO BP9 8-12	08 à 12mm	9mm	0
014621	CO BP9 10-16	10 à 16mm	9mm	0
014622	CO BP9 12-22	12 à 22mm	9mm	0
014634	CO BP9 16-27	16 à 27mm	9mm	0
014637	CO BP9 20-32	20 à 32mm	9mm	0
014639	CO BP9 25-40	25 à 40mm	9mm	0
014642	CO BP9 30-45	30 à 45mm	9mm	0
014645	CO BP9 32-50	32 à 50mm	9mm	0
044453	CO BP9 50-70	50 à 70mm	9mm	0
045100	CO BP9 40-60	40 à 60mm	9mm	0
045101	CO BP9 60-80	60 à 80mm	9mm	0
045102	CO BP9 70-90	70 à 90mm	9mm	0
045103	CO BP9 80-100	80 à 100mm	9mm	0
045104	CO BP9 90-110	90 à 110mm	9mm	0
045105	CO BP9 100-120	100 à 120mm	9mm	0
045106	CO BP9 110-130	110 à 130mm	9mm	0
045107	CO BP9 120-140	120 à 140mm	9mm	0
045108	CO BP9 130-150	130 à 150mm	9mm	0
045109	CO BP9 140-160	140 à 160mm	9mm	0

Collier inox à bande pleine 9mm



Collier inox à bande pleine 9mm

Matière : acier inox

Code	Référence	D1	D2	Poids
045121	CO BP9 INOX 8-12	8 à 12mm	9mm	0
045122	CO BP9 INOX 10-16	10 à 16mm	9mm	0
045123	CO BP9 INOX 12-22	12 à 22mm	9mm	0
045124	CO BP9 INOX 16-27	16 à 27mm	9mm	0
045125	CO BP9 INOX 20-32	20 à 32mm	9mm	0
045127	CO BP9 INOX 25-40	25 à 40mm	9mm	0
045128	CO BP9 INOX 30-45	30 à 45mm	9mm	0
045129	CO BP9 INOX 32-50	32 à 50mm	9mm	0
045130	CO BP9 INOX 40-60	40 à 60mm	9mm	0
045131	CO BP9 INOX 50-70	50 à 70mm	9mm	0
045132	CO BP9 INOX 60-80	60 à 80mm	9mm	0
045133	CO BP9 INOX 70-90	70 à 90mm	9mm	0
045135	CO BP9 INOX 80-100	80 à 100mm	9mm	0
045136	CO BP9 INOX 90-110	90 à 110mm	9mm	0
045138	CO BP9 INOX 100-120	100 à 120mm	9mm	0
045139	CO BP9 INOX 110-130	110 à 130mm	9mm	0
045140	CO BP9 INOX 120-140	120 à 140mm	9mm	0
045141	CO BP9 INOX 130-150	130 à 150mm	9mm	0
045142	CO BP9 INOX 140-160	140 à 160mm	9mm	0

Collier acier à bande pleine 12mm



Collier acier à bande pleine 12mm

Matière : acier

Code	Référence	D1	D2	Poids
014648	CO BP12 16-27	16 à 27mm	12mm	0
014650	CO BP12 20-32	20 à 32mm	12mm	0
014654	CO BP12 25-40	25 à 40mm	12mm	0
014659	CO BP12 32-50	32 à 50mm	12mm	0
014660	CO BP12 40-60	40 à 60mm	12mm	0
014662	CO BP12 60-80	60 à 80mm	12mm	0
014663	CO BP12 70-90	70 à 90mm	12mm	0
014664	CO BP12 80-100	80 à 100mm	12mm	0
014665	CO BP12 90-110	90 à 110mm	12mm	0
014666	CO BP12 100-120	100 à 120mm	12mm	0
014667	CO BP12 110-130	110 à 130mm	12mm	0
014668	CO BP12 120-140	120 à 140mm	12mm	0
014669	CO BP12 130-150	130 à 150mm	12mm	0
045112	CO BP12 140-160	140 à 160mm	12mm	0
045114	CO BP12 150-170	150 à 170mm	12mm	0
045115	CO BP12 160-180	160 à 180mm	12mm	0
045116	CO BP12 170-190	170 à 190mm	12mm	0
045117	CO BP12 180-200	180 à 200mm	12mm	0
045118	CO BP12 190-210	190 à 210mm	12mm	0
045119	CO BP12 200-220	200 à 220mm	12mm	0

Collier inox à bande pleine 12mm



Collier inox à bande pleine 12mm

Matière : acier inox

Code	Référence	D1	D2	Poids
045144	CO BP12 INOX 16-27	16 à 27mm	12mm	0
045145	CO BP12 INOX 20-32	20 à 32mm	12mm	0
045146	CO BP12 INOX 25-40	25 à 40mm	12mm	0
045147	CO BP12 INOX 30-45	30 à 45mm	12mm	0
045148	CO BP12 INOX 32-50	32 à 50mm	12mm	0
045149	CO BP12 INOX 40-60	40 à 60mm	12mm	0
045150	CO BP12 INOX 50-70	50 à 70mm	12mm	0
045151	CO BP12 INOX 60-80	60 à 80mm	12mm	0
045152	CO BP12 INOX 70-90	70 à 90mm	12mm	0
045153	CO BP12 INOX 80-100	80 à 100mm	12mm	0
045154	CO BP12 INOX 90-110	90 à 110mm	12mm	0
045155	CO BP12 INOX 100-120	100 à 120mm	12mm	0
045156	CO BP12 INOX 110-130	110 à 130mm	12mm	0
045157	CO BP12 INOX 120-140	120 à 140mm	12mm	0
045158	CO BP12 INOX 130-150	130 à 150mm	12mm	0
045159	CO BP12 INOX 140-160	140 à 160mm	12mm	0
045160	CO BP12 INOX 150-170	150 à 170mm	12mm	0
045161	CO BP12 INOX 160-180	160 à 180mm	12mm	0
045162	CO BP12 INOX 170-190	170 à 190mm	12mm	0
045163	CO BP12 INOX 180-200	180 à 200mm	12mm	0

Collier à tourillon acier



Collier acier à tourillon

Matière : acier

Code	Référence	D1	D2	Poids
045056	COL TOURILLONS 17-19/18	17 à 19mm	18mm	0
045055	COL TOURILLONS 20-22/18	20 à 22mm	18mm	0
045054	COL TOURILLONS 23-25/18	23 à 25mm	18mm	0
045057	COL TOURILLONS 26-28/18	26 à 28mm	18mm	0
045053	COL TOURILLONS 29-31/20	29 à 31mm	20mm	0
045052	COL TOURILLONS 32-35/20	32 à 35mm	20mm	0
045051	COL TOURILLONS 36-39/20	36 à 39mm	20mm	0
045027	COL TOURILLONS 40-43/20	40 à 43mm	20mm	0
045028	COL TOURILLONS 44-47/22	44 à 47mm	22mm	0
045049	COL TOURILLONS 48-51/22	48 à 51mm	22mm	0
045029	COL TOURILLONS 52-55/22	52 à 55mm	22mm	0
045179	COL TOURILLONS 56-59/20	56 à 59mm	20mm	0
045030	COL TOURILLONS 60-63/22	60 à 63mm	22mm	0
045031	COL TOURILLONS 64-67/22	64 à 67mm	22mm	0
045048	COL TOURILLONS 68-73/24	68 à 73mm	24mm	0
045032	COL TOURILLONS 74-79/24	74 à 79mm	24mm	0
045033	COL TOURILLONS 80-85/24	80 à 85mm	24mm	0
045034	COL TOURILLONS 86-91/24	86 à 91mm	24mm	0
045025	COL TOURILLONS 92-97/24	92 à 97mm	24mm	0
045047	COL TOURILLONS 98-103/24	98 à 103mm	24mm	0
045035	COL TOURILLONS 104-112/24	104 à 112mm	24mm	0.142
045038	COL TOURILLONS 113-121/24	113 à 121mm	24mm	0.143
045023	COL TOURILLONS 122-130/24	122 à 130mm	24mm	0.148
045024	COL TOURILLONS 131-139/26	131 à 139mm	26mm	0.21
045039	COL TOURILLONS 140-148/26	140 à 148mm	26mm	0.204
045022	COL TOURILLONS 149-161/26	149 à 161mm	26mm	0
045040	COL TOURILLONS 162-174/26	162 à 174mm	26mm	0.228
045041	COL TOURILLONS 175-187/26	175 à 187mm	26mm	0
045042	COL TOURILLONS 188-200/26	188 à 200mm	26mm	0
045043	COL TOURILLONS 201-213/26	201 à 213mm	26mm	0
045044	COL TOURILLONS 214-226/26	214 à 226mm	26mm	0
045045	COL TOURILLONS 227-239/26	227 à 239mm	26mm	0
056300	COL TOURILLONS 252-265/30	252 à 265mm	30mm	0
056293	COL TOURILLONS 257-270/26	257 à 270mm	26mm	0
024465	COL TOURILLONS 265-278/30	265 à 278mm	30mm	0
065804	COL TOURILLONS 295-320/30	295 à 320mm	30mm	0

Collier à tourillon inox

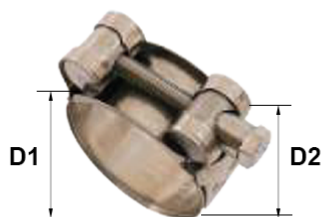

Collier à tourillon inox

Matière : Inox

Code	Référence	D1	D2	Poids
045061	COL TOURILLONS INOX 17-19/18	17 à 19mm	18mm	0
045063	COL TOURILLONS INOX 20-22/18	20 à 22mm	18mm	0
045064	COL TOURILLONS INOX 23-25/18	23 à 25mm	18mm	0
035083	COL TOURILLONS INOX 25-27/18	25 à 27mm	18mm	0
045065	COL TOURILLONS INOX 26-28/18	26 à 28mm	18mm	0
045066	COL TOURILLONS INOX 29-31/20	29 à 31mm	20mm	0
045067	COL TOURILLONS INOX 32-35/20	32 à 35mm	20mm	0
035078	COL TOURILLONS INOX 34-37/18	34 à 37mm	18mm	0
045068	COL TOURILLONS INOX 36-39/20	36 à 39mm	20mm	0.057
045069	COL TOURILLONS INOX 40-43/20	40 à 43mm	20mm	0
045070	COL TOURILLONS INOX 43-46/20	43 à 46mm	20mm	0
045071	COL TOURILLONS INOX 48-51/20	48 à 51mm	20mm	0
045072	COL TOURILLONS INOX 52-55/20	52 à 55mm	20mm	0
045073	COL TOURILLONS INOX 56-59/20	56 à 59mm	20mm	0
045074	COL TOURILLONS INOX 60-63/20	60 à 63mm	20mm	0
045075	COL TOURILLONS INOX 64-67/20	64 à 67mm	20mm	0
045076	COL TOURILLONS INOX 68-73/25	68 à 73mm	25mm	0
045077	COL TOURILLONS INOX 74-79/25	74 à 79mm	25mm	0
045078	COL TOURILLONS INOX 80-85/25	80 à 85mm	25mm	0
045079	COL TOURILLONS INOX 86-91/25	86 à 91mm	25mm	0
045080	COL TOURILLONS INOX 92-97/25	92 à 97mm	25mm	0
045081	COL TOURILLONS INOX 98-103/25	98 à 103mm	25mm	0
045082	COL TOURILLONS INOX 104-112/25	104 à 112mm	25mm	0
045083	COL TOURILLONS INOX 113-121/25	113 à 121mm	25mm	0.143
045084	COL TOURILLONS INOX 122-130/25	122 à 130mm	25mm	0
045085	COL TOURILLONS INOX 131-139/28	131 à 139mm	28mm	0
045088	COL TOURILLONS INOX 140-148/28	140 à 148mm	28mm	0
045089	COL TOURILLONS INOX 149-161/28	149 à 161mm	28mm	0
045091	COL TOURILLONS INOX 162-174/28	162 à 174mm	28mm	0
045092	COL TOURILLONS INOX 175-187/28	175 à 187mm	28mm	0
045090	COL TOURILLONS INOX 188-200/28	188 à 200mm	28mm	0
045093	COL TOURILLONS INOX 201-213/28	201 à 213mm	28mm	0
045094	COL TOURILLONS INOX 214-226/28	214 à 226mm	28mm	0
045095	COL TOURILLONS INOX 227-239/28	227 à 239mm	28mm	0
045096	COL TOURILLONS INOX 240-252/28	240 à 252mm	28mm	0

Collier demi-coquille alu



Collier demi-coquille alu
(livré avec visserie)

Matière : Aluminium
D2 = DN (diamètre interne du tuyau)

Code	Référence	D1	D2	Poids
027438	COQUILLE ALU DN13 / 22-25	22 à 25mm	13mm	0
027439	COQUILLE ALU DN19 / 30-33	30 à 33mm	19mm	0
042773	COQUILLE ALU DN25 / 34-36	34 à 36mm	25mm	0
006658	COQUILLE ALU DN25 / 36-39	36 à 39mm	25mm	0
042772	COQUILLE ALU DN32 / 42-43	42 à 43mm	32mm	0
006659	COQUILLE ALU DN32 / 43-46	43 à 46mm	32mm	0
044996	COQUILLE ALU DN32 / 47-50	47 à 50mm	32mm	0
042771	COQUILLE ALU DN38 / 47/49	47 à 49mm	38mm	0
006660	COQUILLE ALU DN38 / 50-53	50 à 53mm	38mm	0
044997	COQUILLE ALU DN38 / 53-56	53 à 56mm	38mm	0
044998	COQUILLE ALU DN38 / 57-60	57 à 60mm	38mm	0
044999	COQUILLE ALU DN40 / 53-56	53 à 56mm	40mm	0
045000	COQUILLE ALU DN40 / 58-61	58 à 61mm	40mm	0
045001	COQUILLE ALU DN45 / 58-61	58 à 61mm	45mm	0
044993	COQUILLE ALU DN50 / 52-54	52 à 54mm	50mm	0
042770	COQUILLE ALU DN50 / 59-61	59 à 61mm	50mm	0
044093	COQUILLE ALU DN50 / 61-63	61 à 63mm	50mm	0
027440	COQUILLE ALU DN50 / 63-67	63 à 67mm	50mm	0
027441	COQUILLE ALU DN50 / 69-71	69 à 71mm	50mm	0
042774	COQUILLE ALU DN63 / 74-76	74 à 76mm	63mm	0
006661	COQUILLE ALU DN63 / 78-82	78 à 82mm	63mm	0
045002	COQUILLE ALU DN63 / 84-87	84 à 87mm	63mm	0
006662	COQUILLE ALU DN75 / 88-93	88 à 93mm	75mm	0
023975	COQUILLE ALU DN75 / 94-97	94 à 97mm	75mm	0
045003	COQUILLE ALU DN75 / 86-88	86 à 88mm	75mm	0
045004	COQUILLE ALU DN80 / 94-97	94 à 97mm	80mm	0
040530	COQUILLE ALU DN90 / 101-105	101 à 105mm	90mm	0
045005	COQUILLE ALU DN100 / 112-114	112 à 114mm	100mm	0
025055	COQUILLE ALU DN100 / 114-119	114 à 119mm	100mm	0
044995	COQUILLE ALU DN100 / 118-122	118 à 122mm	100mm	0
045006	COQUILLE ALU DN100 / 122-126	112 à 126mm	100mm	0
045007	COQUILLE ALU DN100 / 126-130	126 à 130mm	100mm	0
045008	COQUILLE ALU DN100 / 130-134	130 à 134mm	100mm	0
027442	COQUILLE ALU DN125 / 143-148	143 à 148mm	125mm	0
027443	COQUILLE ALU DN150 / 168-174	168 à 174mm	150mm	0
027444	COQUILLE ALU DN200 / 222-229	222 à 229mm	200mm	0

Code	Référence	D1	D2	Poids
045009	COQUILLE ALU DN200 / 230-239	230 à 239mm	200mm	0

Collier demi-coquille inox



Collier demi-coquille inox
(livré avec visserie)

Matière : inox
D2 = DN (diamètre interne du tuyau)

Code	Référence	D1	D2	Poids
027445	COQUILLE INOX DN13 / 22-25	22 à 25mm	13mm	0
027446	COQUILLE INOX DN19 / 30-33	30 à 33mm	19mm	0
016622	COQUILLE INOX DN25 / 36-39	36 à 39mm	25mm	0
016623	COQUILLE INOX DN32 / 43-46	43 à 46mm	32mm	0
016624	COQUILLE INOX DN38 / 50-53	50 à 53mm	38mm	0
027447	COQUILLE INOX DN50 / 60-63	60 à 63mm	50mm	0
016625	COQUILLE INOX DN50 / 63-67	63 à 67mm	50mm	0
027448	COQUILLE INOX DN63 / 74-77	74 à 77mm	63mm	0
016626	COQUILLE INOX DN63 / 78-82	78 à 82mm	63mm	0
045016	COQUILLE INOX DN65 / 78-82	78 à 82mm	65mm	0
027449	COQUILLE INOX DN75 / 86-90	86 à 90mm	75mm	0
027450	COQUILLE INOX DN75 / 88-93	88 à 93mm	75mm	0
045017	COQUILLE INOX DN100 / 114-199	114 à 199mm	100mm	0

Etrier pour tube (acier)

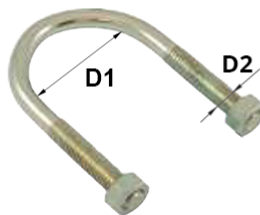

Etrier pour tube (acier)
Avec 2 écrous montés

Matière : Acier bichromaté

Code	Référence	D1	D2	Poids
055116	ETRIER ACIER 1/4	1/4	6mm	0
055115	ETRIER ACIER 3/8	3/8	6mm	0
055114	ETRIER ACIER 1/2	1/2	6mm	0
041019	ETRIER ACIER 3/4	3/4	6mm	0
041020	ETRIER ACIER 1"	1"	6mm	0
054050	ETRIER ACIER 1*1/2	1*1/2	8mm	0
055117	ETRIER ACIER 1*1/4	1*1/4	8mm	0
055118	ETRIER ACIER 2"	2"	8mm	0
055119	ETRIER ACIER 2*1/2	2*1/2	10mm	0
055120	ETRIER ACIER 3"	3"	10mm	0
055121	ETRIER ACIER 4"	4"	10mm	0
068597	ETRIER ACIER 8"	8"	14mm	0

Collier rilsan (serre cable)

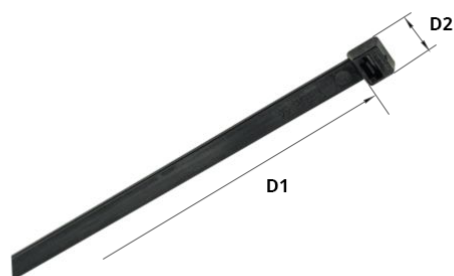

Collier rilsan (serre cable)

Conditionnement : sachet de 100 pièces
Matière : polyamide

Code	Référence	D1	D2	Poids
NOIR				
025057	CO RILSAN 100X2.5 NOIR / 100	100mm	2.5mm	0
025058	CO RILSAN 140X3.5 NOIR / 100	140mm	3.5mm	0
025108	CO RILSAN 180X4.5 NOIR / 100	180mm	4.5mm	0
030193	CO RILSAN 180X7,5 NOIR / 100	180mm	7.5mm	0
025059	CO RILSAN 200X3.5 NOIR / 100	200mm	3.5mm	0
025109	CO RILSAN 200X4.5 NOIR / 100	200mm	4.5mm	0
030189	CO RILSAN 240X7,5 NOIR / 100	240mm	7.5mm	0
025060	CO RILSAN 280X3.5 NOIR / 100	280mm	3.5mm	0
030197	CO RILSAN 280X4,5 NOIR / 100	280mm	4.5mm	0
030190	CO RILSAN 280X7,5 NOIR / 100	280mm	7.5mm	0
030195	CO RILSAN 360X4,5 NOIR / 100	360mm	4.5mm	0
030191	CO RILSAN 360X7,5 NOIR / 100	360mm	7.5mm	0
030194	CO RILSAN 540X7,5 NOIR / 100	540mm	7.5mm	0
030192	CO RILSAN 780X9,0 NOIR / 100	780mm	9mm	0
BLANC				
025883	CO RILSAN 100X2.5 BLANC / 100	100mm	2.5mm	0
028599	CO RILSAN 140X3.5 BLANC / 100	140mm	3.5mm	0
030196	CO RILSAN 180X4,5 BLANC / 100	180mm	4.5mm	0
030200	CO RILSAN 200X2,5 BLANC / 100	200mm	2.5mm	0
030201	CO RILSAN 200X3,5 BLANC / 100	200mm	3.5mm	0
030202	CO RILSAN 280X3,5 BLANC / 100	280mm	3.5mm	0
030204	CO RILSAN 280X7,5 BLANC / 100	280mm	7.5mm	0
030198	CO RILSAN 360X7,5 BLANC / 100	360mm	7.5mm	0
082877	CO RILSAN 380X4,5 BLANC / 100	380mm	4.5mm	0
030205	CO RILSAN 750X7,5 BLANC / 100	750mm	7.5mm	0
BLANC				
030199	CO RILSAN 240X7,5 BLANC / 100	240mm	7.5mm	0
BLEU				
045190	CO RILSAN 200X2.5 BLEU / 100	200mm	2.5mm	0
088083	CO RILSAN 200X4.5 BLEU / 100	200mm	4.5mm	0
BRUN				
045191	CO RILSAN 200X2.5 BRUN / 100	200mm	2.5mm	0
GRIS				
045192	CO RILSAN 200X2.5 GRIS / 100	200mm	2.5mm	0
JAUNE				
045193	CO RILSAN 200X2.5 JAUNE / 100	200mm	2.5mm	0
088085	CO RILSAN 200X4.5 JAUNE / 100	200mm	4.5mm	0
ORANGE				
045194	CO RILSAN 200X2.5 ORANGE / 100	200mm	2.5mm	0

Code	Référence	D1	D2	Poids
ROUGE				
045195	CO RILSAN 188X4.8 ROUGE / 100	188mm	4.8mm	0
088082	CO RILSAN 200X4.5 ROUGE / 100	200mm	4.5mm	0
VERT				
045196	CO RILSAN 188X4.8 VERT / 100	188mm	4.8mm	0
088084	CO RILSAN 200X4.5 VERT / 100	200mm	4.5mm	0
VIOLET				
045197	CO RILSAN 188X4.8 VIOLET / 100	188mm	4.8mm	0

Collier type SL

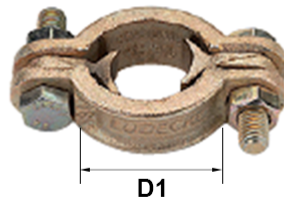

Collier type SL (2 boucles avec baguettes libres)

Matière : Acier zingué
Norme : DIN 20039A
Pression nominale : 16 bars

Code	Référence	D1	D2	Poids
049065	COLLIER SL 29	22 à 29mm		0
030055	COLLIER SL 40	32 à 40mm		0
012689	COLLIER SL 49	39 à 49mm		0
049066	COLLIER SL 34	41 à 48mm		0
044121	COLLIER SL 60	48 à 60mm		0
012690	COLLIER SL 72	56 à 72mm		0
049063	COLLIER SL 76	60 à 76mm		0
049064	COLLIER SL 94	77 à 94mm		0

Collier type SK (à griffes)



Collier type SK (2 boucles avec baguettes libres et griffes de sécurité)

Matière : acier zingué
Norme : Din 20039B
Pression nominale : 25 bars

Code	Référence	D1	D2	Poids
049069	COLLIER SK 29	22 à 29mm		0
049070	COLLIER SK 34	28 à 32mm		0
049071	COLLIER SK 39	35 à 42mm		0
049072	COLLIER SK 44	42 à 45mm		0
049073	COLLIER SK 51	45 à 53mm		0
049074	COLLIER SK 60	55 à 60mm		0
049075	COLLIER SK 73	60 à 73mm		0
049076	COLLIER SK 75	86 à 102mm		0

Code	Référence	D1	D2	Poids
045770	REDUC 139.7X133.0	139.7mm	133mm	0
045771	REDUC 159.0X88.9	159mm	88.9mm	0
045772	REDUC 159.0X108.0	159mm	108mm	0
045773	REDUC 159.0X114.3	159mm	114.3mm	0
045774	REDUC 159.0X133.0	159mm	133mm	0
045775	REDUC 159.0X139.7	159mm	139.7mm	0
045776	REDUC 168.3X88.9	168.3mm	88.9mm	0
045778	REDUC 168.3X101.6	168.3mm	101.6mm	0
045779	REDUC 168.3X114.3	168.3mm	114.3mm	0
045780	REDUC 168.3X133.0	168.3mm	133mm	0
045781	REDUC 168.3X139.7	168.3mm	139.7mm	0
045782	REDUC 168.3X159.0	168.3mm	159mm	0
045783	REDUC 193.7X114.3	193.7mm	114.3mm	0
045784	REDUC 193.7X133.0	193.7mm	133mm	0
045785	REDUC 193.7X139.7	193.7mm	139.7mm	0
045786	REDUC 193.7X168.3	193.7mm	168.3mm	0
045787	REDUC 219.1X114.3	219.1mm	114.3mm	0
045788	REDUC 219.1X133.0	219.1mm	133mm	0
045789	REDUC 219.1X139.7	219.1mm	139.7mm	0
045790	REDUC 219.1X159.0	219.1mm	159mm	0
045791	REDUC 219.1X168.3	219.1mm	168.3mm	0
045745	REDUC 48.3X42.4	48.3mm	42.4mm	0



CONTACT

Pour toute demande ou information complémentaire, veuillez nous contacter à l'adresse mail suivante : magasin@cihal.fr

**CATALOGUE
CIHAL**



Cihal Forbach :

Technopole Forbach Sud 113
Rue Robert Bunsen 57460 -
Behren lès Forbach, France



Cihal Alsace :

22 Rue Hannah Arendt 67200
Strasbourg, France



PJHY :

1 All. des Bonnetons
54425 - Pulnoy France

